

Instruction Manual

SW-63

Contents

Product introduction.....	1
Carried Standard.....	1
Structure.....	2
Installation.....	3
Safety Instructions.....	4
Directions for use.....	5
Application notice.....	6
Maintenance.....	7
Trouble Shooting.....	8

Thanks for purchasing our products, please read carefully the instruction manual and keep the manual properly so as to facilitate your reference at later time.

1. In order to guarantee the product's quality, this product adopts advanced refrigeration and manufacturing technology. In addition, the strict comprehensive detection technology and a series of imported equipment are adopted.
2. Good-quality compressors are be used so that the refrigerating system is reasonable and the temperature range is wide. The most important, the power consumption is low.
3. This is a polisher high, durable and corrosion-resistant cooler because its casing and inner room are adopting the stainless steel.
4. Transparent tempering glass door with the LED light make the cooler reach light and display effect.
5. This cooler used the roll-bond evaporator which is beautiful and fast refrigerating.
6. The door uses hollow glass to avoid any condensation and make the goods in coolers more clearly.
7. The casing adopt the environmental material to foam
8. All the products with the approval of CCC GS CE CB ETL RoHs and so on
9. This product can be used in chateau, bar, store, restaurant, hotel, household, enterprise and so on.

10. This product perform the following standard:

- GB4706.1 < Household and similar electrical appliances, the part one: General requirements >
- GB4706.13 < Household and similar electrical appliances, the special requirements of refrigeration equipment, ice cream and ice making machine >
- GB/T8059.1 < Household refrigerating appliances cooler >
- GB/T 23777-2009 < wine cooler >
- GB4343.1 < Electromagnetic compatibility household appliances electric tools and similar apparatus the first part to launch >
- GB17625.1 < Electrical compatibility limits for harmonic current emission limits (device input current in each phase $\leq 16A$) >
- GB 19606 < Household and similar electrical noise limit >

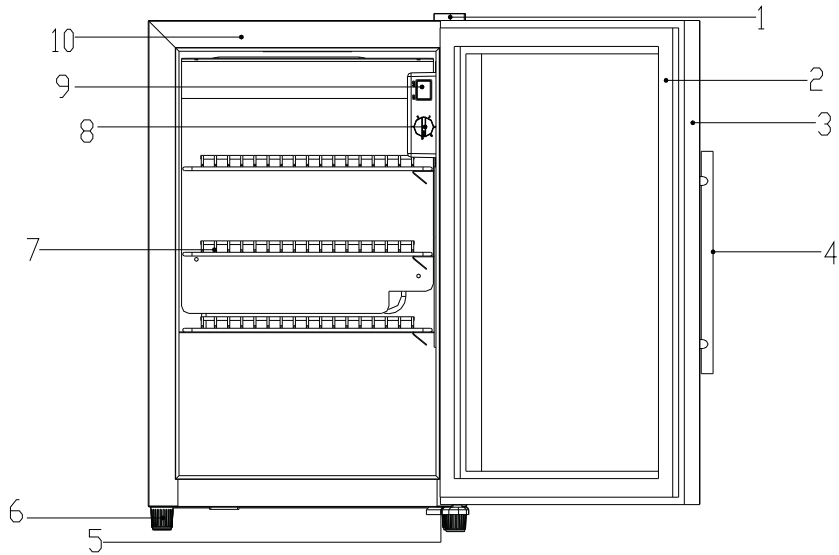

1. Hinge Cover 2. Door Gasket 3. Door Frame 4. Door Handle 5. Lower Hinge
6. Foot 7. Rack 8. Thermostat switch knob 9. LED Light Switch 10. Casing

Our company reserves the right to change the product. The appearance of the units that you purchase might be slightly different from the Manual, but it does not affect your proper operations and usage.

Transport

- Turn off this appliance and pull the plug
- The inclination shall not exceed 45° in case the compressor fault.
- Please handle with care. Because the door is glass door.

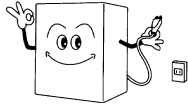

Installation

Remove the packing material, then, the cooler need to be placed in a smooth and solid place

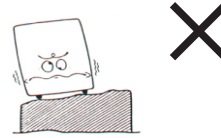

Moving

Don't push the glass door in case the glass from breaking into pieces.

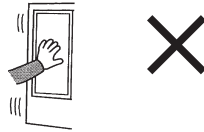

The cooler shall be placed at a good ventilation place.

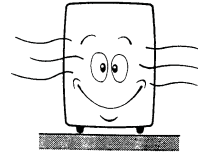

Don't frequent electricity

When power cut or disconnect plug, please re-connect the plug after 5 minutes.

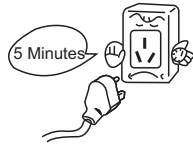

Take out the goods

Please take out all of the goods before moving, in case of the goods fall.

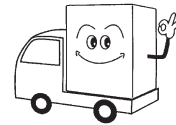

Should be equipped with specialized power socket and fuse

For the normal use, the power should be 187v-242v~, 50Hz and equipped with the triplex receptacle (250V, 10A) and fuse (6A), power socket should have a reliable grounding line



Don't use a power socket with many appliances

Otherwise it will cause the line heating, even fire

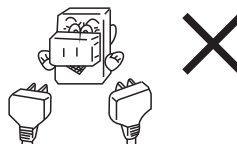

Don't damage the power cord and power socket

Please avoid the foot or universal wheel to touch and crush the line so that be caused by electrical leaks, even fire

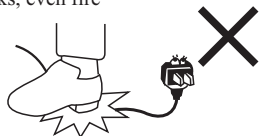

Don't store or near flammable products

It is prohibited to store flammable and explosive materials, such as diethyl ether, gasoline, ethyl alcohol, fire and so on. The coolers is forbidden to near dangerous goods.

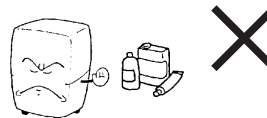

Don't put electrical appliances into the cooler

Don't put any electric appliances into the products. Otherwise it may cause danger



Don't spray flammable near the cooler.

It is prohibited to spray combustibile and explosive goods, such as oil paint

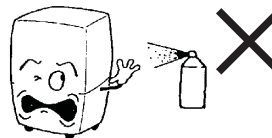

1、 Application method:

1. 1 Before connecting the power, please check the power Cord, the light switch and the thermostat switch knob whether ok or not.

1. 2 Temperature setting:

The temperature setting has 1~6 gears, the first is the highest temp. and the sixth is the lowest temp. You can adjust according to your needs

1. 3 Setting of power and light:

Slide the Led light switch can control the LED light.

**Switch of LED
light**

**Thermostat switch
knob**

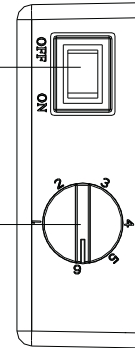

1. When the power cord is damaged, it must be repaired by professionals.
2. Don't touch the compressor, because the temperature will be a little high.
3. Don't hang anything on the door, otherwise, products will fall.
4. Please keep cleaning on both sides of product, otherwise, the refrigeration effect will be affected.
5. When the product won't be used for a long time, please follow below instruction:
 - 1) Unplug the power plug and take out all of the items inside the products.
 - 2) Please clean the inside and outside of the products and make it fully dry
 - 3) Away from the children's play area, in case of the children enter the cooler.
6. Don't damage the refrigeration cycle tube. The refrigeration cycle tube was installed inside and outside cabinet. If this parts is broken, it will cause the cooling pipeline rupture.

1. Fully clean the inside and outside of the products.

- 1) Please mop and clean with a soft cloth, or use soft cloth with little neutral tableware detergent to clean, then use dry soft cloth to wipe it dry.
- 2) Please clean and maintenance the cooler regularly.

2. Attention:

- 1) For safety, please unplug the products before cleaning
- 2) Don't flush thoroughly with water directly.
- 3) Please clean the product regularly. Plastic parts are easy to be damaged when the cooling oil fumes is stick for a long time, such as door gasket, door frame and so on.
- 4) The following items will damage the product's surface:
Alkaline detergent, toilet soap, milled powder, boiling water, sweeper, lacquer thinner, acetone, methylbenzene and so on.



Trouble Shooting

problem	solution
no working	plug or not
Cooling problem	Fuse break
	No power
	Ventilation not well
	Hear source near the item
	Door close not well or door open too long
	Door sealing problem or deformation
	Bottles loading too much in same shelf
	Air inlet or outlet block
	Control Setting problem
	Ventilation space in the right & left casing not enough
Noisy	Wine cabinet placed not flat
	Item touch the wall
	Some parts loose or taken off

If through inspection, still cannot eliminate the fault, shall inform stores or maintenance service professionals.

Note: Normal operation for following situation

- 1) When the product is working , hear the sound like running water, it was caused by the refrigerant flows.
- 2) When the weather is hot or the ambient humidity is too big, some parts of the product might has condenser water, such as the product's surface, LED light cover, the door and so on. It is normal phenomenon, it won't affect the safety refrigeration performances. Just need to wipe with dry soft cloth.

Warning:

Refrigerant and foaming material is flammable. Please take care when Maintenance, Installation, Handling and processing. Please contact with specialized department for wasted products, and do not discard freely.

matters need attention

Waste disposal tips

Wrapping is used to protect electric appliance during transport and every part of materials are recycled materials.

- Corrugated paperboard/paperboard (made from waste paper)
- Polystyrene block (foam fluoride-free polystyrene)
- Plastic film, bag (polystyrene)
- Packing string (polystyrene)
- Never let child play with packing materials, plastic film may cause suffocation.
- Transport packing materials to public environmental collection depot.

Waste cold wine cabinet still has many valuable raw materials and shall be treated separately in residential area not adopting garbage classification.

- Waste cold wine cabinet shall be scraped timely; take off plug, and remove power soft cable. Destroy lock to prevent such situation that a kid is locked by him/herself when playing the lock.
- Before sending the waste cold wine cabinet to public collection depot, cold circulation system shall not be damaged to ensure that the refrigerant and oil of cold wine cabinet suffers no leakage.
- For situations on waste collection date and collection depot, please consult with local environmental sanitation department or government agency.



Warning



- Refrigerant and foam layer is flammable, Pay attention to the fire when maintenance installation, transportation and handling. Used product need to be recycled by specialized companies, do not arbitrarily discarded.

- It is prohibited to place the machine in a place where is possible to leak corrosive and flammable gas, it is easy to explode or damage the machine.
- The grounding wires cannot be connected with the gas pipe, the water pipe system, the lightning rod and the telephone. If ignore this, it will has the possibility to cause the receiving an electric shock accident.
- Cannot lengthen the power cord without authorization, meanwhile, this appliance couldn't share a socket with other appliance, otherwise, it is easy to cause short circuit or damage the electronic components.
- This product does not contain any spare parts, please do not disassemble. The refrigerant used in this product is combustible, non-professional maintenance personnel shall not repair the machine, improper repair may be the risk of fire or explosion. If the machine is faulty, please contact the service personnel.
- This appliance is not intended for use by persons (including children) with reduced physical, sensory or mental capabilities, or lack of experience and knowledge, unless they have been given supervision or instruction concerning use of the appliance by a person responsible for their safety.
- Children should be supervised to ensure that they do not play with the. appliance.
- If the supply cord is damaged, it must be replaced by the manufacturer, its service agent or similarly qualified person in order to avoid a hazard
- **WARNING:** Keep ventilation openings, in the appliance enclosure or in the built-in structure, clear of obstruction.
- **WARNING:** Do not use mechanical devices or other means to accelerate the defrosting process, other than those recommended by the manufacturer.

- **WARNING:** Do not damage the refrigerant circuit.
 - **WARNING:** Do not use electrical appliances inside the food storage compartments of the appliance, unless they are of the type recommended by the manufacturer.
 - **WARNING:** When positioning the appliance, ensure the supply cord is not trapped or damaged
 - **WARNING:** Do not locate multiple portable socket-outlets or portable power supplies at therear of the appliance.
 - Do not store explosive substances such as aerosol cans with a flammable propellant in this appliance.
 - The plug must can be accessible after the product installed.
 - **DANGER:** Risk of child entrapment. Before you throw away your old:
refrigerator or freezer:
 - * Take off the doors.
 - * Leave the shelves in place so that children may not easily climb inside.
- This appliance is intended to be used in household and similar applications such as
- staff kitchen areas in shops, offices and other working environments;
 - farm houses and by clients in hotels, motels and other residential type environments;
 - bed and breakfast type environments;
 - catering and similar non-retail applications.
 - When the machine is installed, the left and right sides and back must have more than 5cm of the heat dissipation space, the machine can not store. flammable items.
 - During handling, be careful, do not carry from the front and rear of the box, should be tilted from the left and right sides, can not lie down to move the box.