

Skötselråd • Vedligeholdelsesråd • Vedlikeholdsråd • Hoito ohjeet • care advice • Заботиться

SE - Duschväggar

För att underlätta rengöringen av duschdörrar och duschväggar har duscharna stora släta ytor och profiler utan djupa skårer. Missfärgningar tas bort med citron eller vinsyra; skölj noga efteråt. Kalkfläckar tas bort med 50 grader varm hushållsättika: gnid in, låt verka, skölj bort. Upprepa om fläckarna är svåra.

DK - Hafas brusekabiner

For at lette rengöringen af brusedøre og -vægge har vores bruseafsærmninger store glatte overflader og profiler uden dybe riller. Misfarvninger kan fjernes med citronsyre eller eddike (skyl efter). Skrub med en børste, hvis pletterne er genstridige.

NO - Hafa dusjer

For å forenkle rengjøringen av dusjdører og dusjvegger har dusjene store slette glassflater og profiler uten dype sprekker. Missfarging tas bort med sitron eller vinsyre, skylt nøye etterpå. Kalkflekker tas bort med 50 grader varm eddikk: gni inn, la det virke, skylt bort. Gjeta om flekkene er vanskelige å få bort. Gjennom å polere innsiden på dusjveggene i klart glass med Hafa Easy Clean glass forsegles glassoverflaten slik at den blir enklere å rengjøre. Bruk aldri slippende rengjøringsmidler på dine dusjdører/dusjvegger.

FI - Hafa suihkut

Puhdistamisen helpottamiseksi on suihkuovissa ja -seinissä suuret, sileät pinnat. Värjäytymät otetaan pois sitruuna- tai viinihapolla; huuhtelee hyvin käytön jälkeen. Kalkkikerrostumat otetaan pois 50 astetta lämpimällä talousetikalla: hiero pintaan, anna vaikuttaa ja huuhtelee pois.

ENG - Hafa showers

To facilitate the cleaning of shower doors and shower walls, the showers have large smooth surfaces and profiles without deep grooves. Discolouration is removed using citric or tartaric acid, rinse thoroughly afterwards. Limescale stains are removed using household vinegar warmed to 50 degrees: Rub it in, let it act, rinse away. Repeat for tough stains.

RU - HАFА Душевые уголки

Для простоты ухода душевые двери и душевые ограждения имеют большие гладкие поверхности и профили без глубоких борозд. Прозрачности стекла можно добиться применением лимонной или винной кислоты. Известковый налет удаляется с помощью обычного уксуса нагретого до 50°C, нанесите ее на поверхность дождитесь реакции, затем ополосните. Повторите эти действия для стойких пятен.

Hafa® Igloo Wall

Igloo R	L/R mm
30	L/R 300 ±10 L/R 960 ±10
40	L/R 400 ±10 L/R 925 ±10
50	L/R 500 ±10 L/R 880 ±10
60	L/R 600 ±10L/ R 820 ±10
70	L/R 700 ±10L/ R 735 ±10
72	L/R 720 ±10L/ R 720 ±10
80	L/R 800 ±10L/ R 625 ±10
90	L/R 900 ±10L/ R 460 ±10
89	800 ±10/ 950 ±10

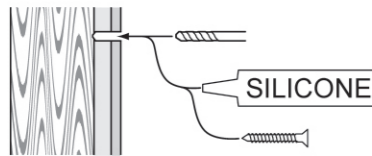
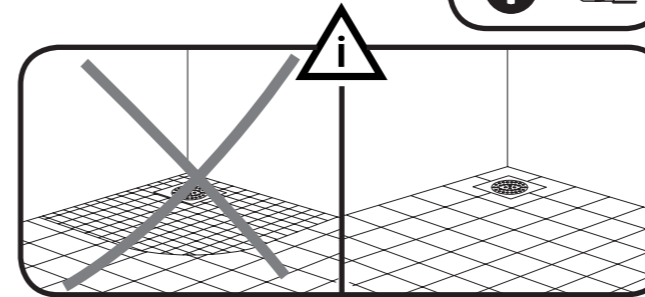
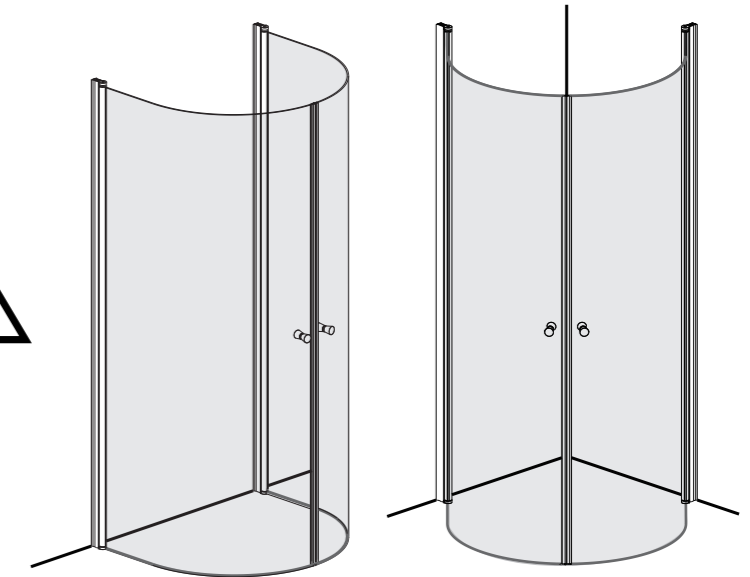
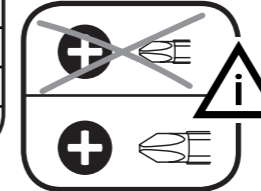

SE

Vid montering på regelvägg måste väggen alltid förstärkas. Alla skruvfästningar skall ske i massiv konstruktion, tex betong, i reglar eller särskild konstruktionsdetalj. Skruvfästning får inte göras enbart i golv-, eller väggskiva. Krav på tätning gäller både i våtzon 1 och 2. Material för tätning ska fästa mot underlaget och vara vattenbeständigt, mögelresistent och åldersbeständigt.

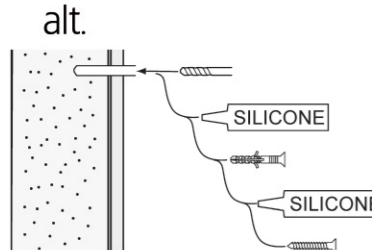

GB

Below are Swedish recommendations: When installing on a stud wall, the wall must always be strengthened. All screws must be fixed to solid structures, such as concrete, studs or special structural components. Screws must not be fixed to flooring or wall sheets alone. Requirements for sealing apply in wet zones 1 and 2. Sealing materials must be fixed to the underlying layer and must be waterproof, mould-resistant and age-resistant.

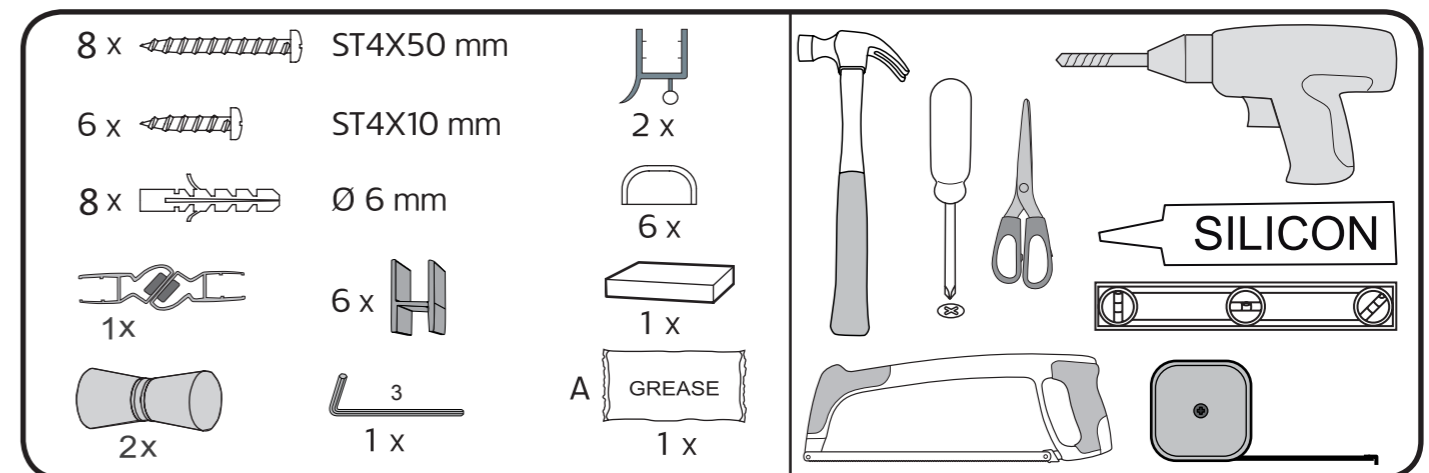
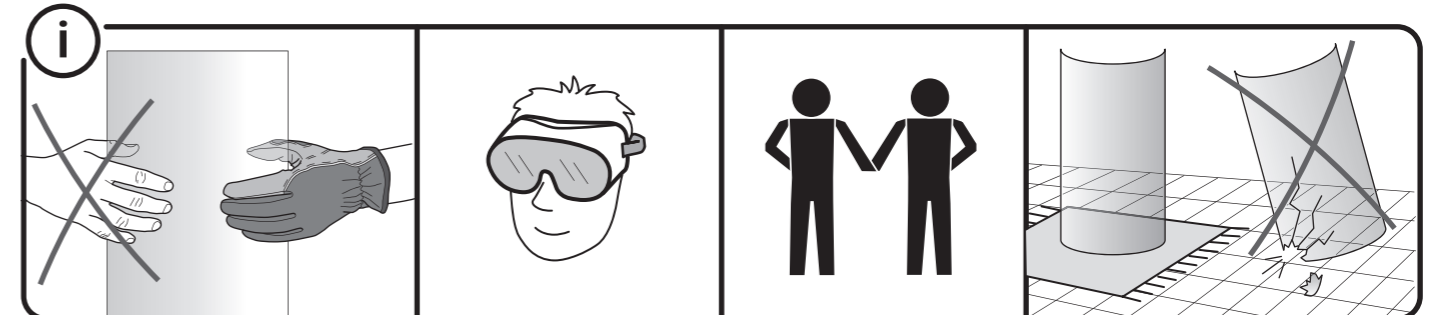

	Hafa Svarvaregatan 5, Box 525 SE-301 80 Halmstad SWEDEN	Garanti/Warranty. Service, resevdelar/spare-parts Sweden: Tel: +46 (0)35 15 44 75 Norway: Tel: +47 69 31 02 30 Finland: Puh: 0207 43 50 00	www.hafa.se www.hafa.dk www.hafabad.no www.hafa.se www.hafabathroom.ru www.hafa.eu	E-mail: service@hafa.se service@hafabad.no
		Hafa Svarvaregatan 5, Box 525 SE-301 80 Halmstad SWEDEN		

	Hafa Svarvaregatan 5, Box 525 SE-301 80 Halmstad SWEDEN	Garanti/Warranty. Service, resevdelar/spare-parts Sweden: Tel: +46 (0)35 15 44 75 Norway: Tel: +47 69 31 02 30 Finland: Puh: 0207 43 50 00	www.hafa.se www.hafa.dk www.hafabad.no www.hafa.se www.hafabathroom.ru www.hafa.eu	E-mail: service@hafa.se service@hafabad.no
		Hafa Svarvaregatan 5, Box 525 SE-301 80 Halmstad SWEDEN		

