

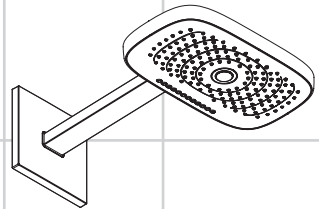





DE	Gebrauchsanleitung / Montageanleitung	2
FR	Mode d'emploi / Instructions de montage	3
EN	Instructions for use / assembly instructions	4
IT	Istruzioni per l'uso / Istruzioni per Installazione	5
ES	Modo de empleo / Instrucciones de montaje	6
NL	Gebruiksaanwijzing / Handleiding	7
DK	Brugsanvisning / Monteringsvejledning	8
PT	Instruções para uso / Manual de Instalação	9
PL	Instrukcja obsługi / Instrukcja montażu	10
CS	Návod k použití / Montážní návod	11
SK	Návod na použitie / Montážny návod	12
ZH	用户手册 / 组装说明	13
RU	Руководство пользователя / Инструкция по монтажу	14
HU	Használati útmutató / Szerelési útmutató	15
FI	Käyttöohje / Asennusohje	16
SV	Bruksanvisning / Monteringsanvisning	17
LT	Vartotojo instrukcija / Montavimo instrukcijos	18
HR	Upute za uporabu / Uputstva za instalaciju	19
TR	Kullanım kılavuzu / Montaj kılavuzu	20
RO	Manual de utilizare / Instrucțiuni de montare	21
EL	Οδηγίες χρήσης / Οδηγία συναρμολόγησης	22
SL	Navodilo za uporabo / Navodila za montažo	23
ET	Kasutusjuhend / Paigaldusjuhend	24
LV	Lietošanas pamācība / Montāžas instrukcija	25
SR	Uputstvo za upotrebu / Uputstvo za montažu	26
NO	Bruksanvisning / Montasjeveiledning	27
BG	Инструкция за употреба / Инструкция за употреба	28
SQ	Udhëzuesi i përdorimit / Udhëzime rreth montimit	29
AR	دليل الاستخدام / تعليمات التجميع	30



Raindance Select
26468000 / 26468400



Sicherheitshinweise

-  Bei der Montage müssen zur Vermeidung von Quetsch- und Schnittverletzungen Handschuhe getragen werden.
-  Das Duschsystem darf nur zu Bade-, Hygiene- und Körperreinigungszwecken eingesetzt werden.
-  Kinder, sowie Erwachsene mit körperlichen, geistigen und / oder sensorischen Einschränkungen dürfen das Duschsystem nicht unbeaufsichtigt benutzen. Personen, die unter Alkohol- oder Drogeneinfluss stehen, dürfen das Duschsystem nicht benutzen.
-  Der Kontakt der Brausestrahlen mit empfindlichen Körperstellen (z. B. Augen) muss vermieden werden. Es muss ein ausreichender Abstand zwischen Brause und Körper eingehalten werden.
-  Der Kopfbrausearm ist nur für das Halten der Kopfbrause ausgelegt, er darf nicht mit weiteren Gegenständen belastet werden!

Montagehinweise

- Vor der Montage muss das Produkt auf Transportschäden untersucht werden.
- Die Armatur muss nach den gültigen Normen montiert, gespült und geprüft werden!



















Technische Daten

Betriebsdruck:	max. 0,6 MPa
Empfohlener Betriebsdruck: (1 MPa = 10 bar = 147 PSI)	0,15 – 0,4 MPa
Heißwassertemperatur:	max. 60 °C
Thermische Desinfektion:	max. 70 °C / 4 min

Dieses Produkt kann nicht in Verbindung mit hydraulisch und thermisch gesteuerten Durchlauferhitzern eingesetzt werden.

Das Produkt ist ausschließlich für Trinkwasser konzipiert!

Symbolerklärung





-  Mitte Duschwanne
-  Warmwasser
-  Kaltwasser
-  Kein essigsäurehaltiges Silikon verwenden!
-  In diesem Bereich ist eine Wandverstärkung notwendig.
-  Unterputz-Ventil
-  Quattro Vierwegeumstellung
-  Trio Universal Absperr- und Umstellventil
-  Der nicht benötigte Abgang muss mit einem Blindstopfen abgedichtet werden.
-  Die Ablaufleistung muss mehr als 50 l/min betragen.
-  Ablauf
-  **Raindrain**
-  **Maße** (siehe Seite 31)
-  **Durchflussdiagramm** (siehe Seite 33)
-  **Bedienung** (siehe Seite 38)
-  **Reinigung** (siehe Seite 39) und beiliegende Broschüre
-  **Serviceteile** (siehe Seite 40)
-  **Prüfzeichen** (siehe Seite 44)



Montage siehe Seite 31



Consignes de sécurité

-  Lors du montage, porter des gants de protection pour éviter toute blessure par écrasement ou coupure.
-  Le système de douche ne doit servir qu'à se laver et à assurer l'hygiène corporelle.
-  Il est interdit aux enfants ainsi qu'aux adultes ayant des insuffisances physiques, psychiques et/ou motoriques d'utiliser la douche sans surveillance. De même, il est interdit à des personnes sous influence d'alcool ou de drogues d'utiliser la douche.
-  Éviter le contact du jet de la douchette avec les parties sensibles du corps (telles par ex. que les yeux). Veiller à respecter un écart suffisant entre la douchette et le corps
-  Le bras de la douchette n'est conçu que pour tenir la douchette et ne doit pas servir à la suspension d'autres objets !

Instructions pour le montage

- Avant son montage, s'assurer que le produit n'a subi aucun dommage pendant le transport
- La robinetterie doit être installée, rincée et contrôlée conformément aux normes valables!

Informations techniques

Pression de service autorisée: max. 0,6 MPa
 Pression de service conseillée: 0,15 - 0,4 MPa
 (1 MPa = 10 bar = 147 PSI)
 Température d'eau chaude: max. 60°C
 Désinfection thermique: max. 70°C / 4 min

Les mitigeurs Hansgrohe ne doivent pas être utilisés avec des chauffe-eau instantané à commande hydraulique ou thermique.

Le produit est exclusivement conçu pour de l'eau potable!

Description du symbole





-  Centre cuvette de douche
-  Eau chaude
-  Eau froide
-  Ne pas utiliser de silicone contenant de l'acide acétique!
-  Le mur n'a pas besoin d'être renforcé à cet endroit
-  Robinet d'arrêt encastré
-  Quattro inverseur quatre voies
- Quattro**
 Trio Robinet d'arrêt avec inverseur
- Trio**
 La sortie non utilisée doit être condamnée avec un bouchon laiton.
-  Le débit de vidage doit être supérieur à 50 l/min.
-  Vidage
-  **Dimensions** (voir page 31)
-  **Diagramme du débit** (voir page 33)
-  **Instructions de service** (voir page 38)
-  **Nettoyage** (voir page 39) et brochure ci-jointe
-  **Pièces détachées** (voir pages 40)
-  **Classification acoustique et débit** (voir page 44)



Montage voir page 31



Safety Notes

-  Gloves should be worn during installation to prevent crushing and cutting injuries.
-  The shower system may only be used for bathing, hygienic and body cleansing purposes.
-  Children as well as adults with physical, mental and/or sensoric impairments must not use this shower system without proper supervision. Persons under the influence of alcohol or drugs are prohibited from using this shower system.
-  Do not allow the streams of the shower touch sensitive body parts (such as your eyes). An adequate distance must be kept between the shower and you.
-  The arm of the shower head is intended only to hold the shower head. Do not load it down with other objects!

Installation Instructions

- Prior to installation, inspect the product for transport damages.
- The fitting must be installed, flushed and tested after the valid norms!



















Technical Data

Operating pressure:	max. 0,6 MPa
Recommended operating pressure:	0,15 - 0,4 MPa (1 MPa = 10 bar = 147 PSI)
Hot water temperature:	max. 60 °C
Thermal disinfection:	max. 70 °C / 4 min

This mixer cannot be used in conjunction with hydraulically, electronically or thermally controlled instantaneous heaters.

The product is exclusively designed for drinking water!

Symbol description





-  Center shower tub
-  Warm water
-  Cold water
-  Do not use silicone containing acetic acid!
-  The wall must be reinforced in this area.
-  Shut off valve
-  Quattro 4-Way Diverter Valve
-  Trio 2-Way Diverter Valve with integrated Shut-off valve
-  Plug the unused outlet.
-  The waste drain performance must be more than 50 l/min.
-  Waste
-  Raindrain
-  **Dimensions** (see page 31)
-  **Flow diagram** (see page 33)
-  **Operation** (see page 38)
-  **Cleaning** (see page 39) and enclosed brochure
-  **Spare parts** (see page 40)
-  **Test certificate** (see page 44)



Assembly see page 31



Indicazioni sulla sicurezza

-  Durante il montaggio, per evitare ferite da schiacciamento e da taglio bisogna indossare guanti protettivi.
-  Il sistema doccia deve essere utilizzato esclusivamente per l'igiene del corpo.
-  I bambini e gli adulti affetti da menomazioni fisiche, psichiche e/osensoriali devono utilizzare il sistema della doccia solo sotto la supervisione di una persona responsabile.
-  Bisogna evitare il contatto fra il getto della doccia e parti del corpo delicate (ad es. gli occhi). Fra il soffione ed il corpo va mantenuta una distanza sufficiente.
-  Il braccio del soffione della doccia è progettato per sostenere solo quest'ultimo, non va sovraccaricato con altri oggetti!

Istruzioni per il montaggio

- Prima del montaggio è necessario controllare che non ci siano stati danni durante il trasporto.
- La rubinetteria deve essere installata, pulita e testata secondo le istruzioni riportate!















Dati tecnici

Pressione d'uso: max. 0,6 MPa
 Pressione d'uso consigliata: 0,15 - 0,4 MPa
 (1 MPa = 10 bar = 147 PSI)
 Temperatura dell'acqua calda: max. 60°C
 Disinfezione termica: max. 70°C / 4 min

I miscelatori non sono compatibili con le caldaie istantanee.

Il prodotto è concepito esclusivamente per acqua potabile!





Descrizione simbolo

-  Centro piatto doccia
-  Acqua calda
-  Acqua fredda
-  Non utilizzare silicone contenente acido acetico!
-  In questa zona è necessario un rinforzo della parete.
-  Rubinetto di arresto
-  Quattro Valvola a quattro vie
- Quattro**
 Trio arresto/deviatore
- Trio**
 Chiudere con un tappo l'uscita non utilizzata.
-  La portata di scarico deve essere superiore a 50 l/min.
-  Scarico
-  **Ingombri** (vedi pagg. 31)
-  **Diagramma flusso** (vedi pagg. 33)
-  **Procedura** (vedi pagg. 38)
-  **Pulitura** (vedi pagg. 39) e brochure allegata
-  **Parti di ricambio** (vedi pagg. 40)
-  **Segno di verifica** (vedi pagg. 44)





Indicaciones de seguridad

-  Durante el montaje deben utilizarse guantes para evitar heridas por aplastamiento o corte.
-  El sistema de ducha solo debe ser utilizado para fines de baño, higiene y limpieza corporal.
-  Niños, así como adultos con limitaciones corporales, mentales y/o sensoriales no deben utilizar el sistema de duchas sin vigilancia. Personas que se encuentran bajo el efecto de alcohol o drogas, no deben utilizar el sistema de duchas.
-  Debe evitarse el contacto del chorro del pulverizador con partes sensibles del cuerpo (por ej. ojos). Debe mantenerse una distancia suficiente entre pulverizador y cuerpo.
-  El brazo del pulverizador de ducha solo está previsto para soportar el pulverizador de ducha y no debe cargarse con otros objetos!

Indicaciones para el montaje

- Antes del montaje se debe examinar el producto contra daños de transporte.
- El grifo tiene que ser instalado, probado y testado, según las normas en vigor.















Datos técnicos

Presión en servicio:	max. 0,6 MPa
Presión recomendada en servicio:	0,15 - 0,4 MPa
(1 MPa = 10 bar = 147 PSI)	
Temperatura del agua caliente:	max. 60 °C
Desinfección térmica:	max. 70 °C / 4 min

Los mezcladores no pueden usarse con calentadores instantáneos mandados hidráulicamente o térmicamente.

El producto ha sido concebido exclusivamente para agua potable.

Descripción de símbolos

-  Centro la plato de ducha
-  Agua caliente
-  Agua fría
-  No utilizar silicona que contiene ácido acético!
-  En este sector es necesario un refuerzo del muro.
-  Llave de paso
-  Quattro válvula de 4 vías
- Quattro**
-  Trio llave de paso y distribuidor
- Trio**
-  La salida que no se utiliza debe ser tapada.
-  El caudal de desagüe debe ser como mínimo de 50 l/min
- >50l/min**
-  Desagüe
- Raindrain**
-  **Dimensiones** (ver página 31)
-  **Diagrama de circulación** (ver página 33)
-  **Manejo** (ver página 38)
-  **Limpiar** (ver página 39) y folleto anexo
-  **Repuestos** (ver página 40)
-  **Marca de verificación** (ver página 44)



Montaje ver página 31



Veiligheidsinstructies

- ⚠ Bij de montage moeten ter voorkoming van knel- en snijwonden handschoenen worden gedragen.
- ⚠ Het douchesysteem mag alleen voor het wassen, hygiënische doeleinden en voor de lichaamreiniging worden gebruikt.
- ⚠ Kinderen en volwassenen met lichamelijke, geestelijke en/of sensorische beperkingen mogen het douchesysteem niet zonder toezicht gebruiken. Personen onder invloed van alcohol of drugs mogen het douchesysteem niet gebruiken.
- ⚠ Het contact van de douchestraal met gevoelige lichaamsdelen (bijv. ogen) moet worden voorkomen. Er moet voldoende afstand tussen douche en lichaam aangehouden worden.
- ⚠ De arm van de hoofddouche is uitsluitend voor het vasthouden van de hoofddouche bedoeld en mag niet met verdere voorwerpen worden belast!

Montage-instructies

- Vóór de montage moet het product gecontroleerd worden op transportschade.
- Leidingen doorspoelen volgens Norm. De mengkraan vervolgens monteren en controleren!

Technische gegevens

Werkdruk: max. max. 0,6 MPa
 Aanbevolen werkdruk: 0,15 – 0,4 MPa
 (1 MPa = 10 bar = 147 PSI)
 Temperatuur warm water: max. 60 °C
 Thermische desinfectie: max. 70 °C / 4 min

Hansgrohe kranen mogen niet in verbinding met hydraulische en thermisch gestuurde geisers geplaatst worden.

Het product is uitsluitend ontworpen voor drinkwater!

Symboolbeschrijving



Midden Douchebak



Warm water



Koud water



Gebruik geen zuurhoudende silicone!



In dit bereik is een wandversterking noodzakelijk.



Inbouwstopkraan



Quattro 4-weg omstelkraan

Quattro



Trio stop- en omstelkraan



Trio

De niet benodigde uitgang moet met een blindstop worden afgedicht.



De afvoercapaciteit moet meer dan 50 l/min bedragen.



Afvoer



Maten (zie blz. 31)



Doorstroomdiagram (zie blz. 33)



Bediening (zie blz. 38)



Reinigen (zie blz. 39) en bijgevoegde brochure



Service onderdelen (zie blz. 40)



Keurmerk (zie blz. 44)



Montage zie blz. 31



Sikkerhedsanvisninger

- △ Ved monteringen skal der bruges handsker for at undgå kvæstelser og snitsår.
- △ Brusersystemet må kun bruges til bade-, hygiejne og rengøringsformål.
- △ Børn som også voksne med fysiske, mentale og / eller sensoriske begrænsninger må ikke bruge brusersystemet uden opsyn. Personer som er under indflydelse af alkohol eller narkotika må ikke bruge brusersystemet.
- △ Bruserstrålens kontakt med sensitive områder (f.eks. øjne) skal undgås. Der skal være en tilstrækkelig afstand mellem bruseren og kroppen.
- △ Stangen til hovedbruseren er kun beregnet til at holde hovedbruseren. Den må ikke belastes med andre genstande!

Monteringsanvisninger

- Før monteringen skal produktet kontrolleres for transportskader.
- Ifølge gældende regler, skal armaturet monteres, skylles igennem og afprøves.

















Tekniske data

Driftstryk:	max. 0,6 MPa
Anbefalet driftstryk:	0,15 - 0,4 MPa
(1 MPa = 10 bar = 147 PSI)	
Varmtvandstemperatur:	max. 60 °C
Termisk desinfektion:	max. 70 °C / 4 min

Hansgrohe armaturer kan ikke anvendes i forbindelse med hydraulisk og termisk styrede vandvarmere.

Produktet er udelukkende beregnet til drikkevand!

Symbolbeskrivelse





-  Midt brusekar
-  Varmt vand
-  Kold vand
-  Der må ikke benyttes eddikesyreholdig silikone!
-  I dette område er en forstærkning af væggen nødvendigt.
-  Afspæringsventil
-  Quattro 4-weg omstelkraan
- Quattro**
 Trio afspæringsventil og omskifter
- Trio**
 Afgangen, der ikke benyttes, skal afproppes.
-  Afløbskapaciteten skal være mere end 50 l/min.
- >50l/min**
 Afløb
- Raindrain**
 **Målene** (se s. 31)
-  **Gennemstrømningsdiagram** (se s. 33)
-  **Brugsanvisning** (se s. 38)
-  **Rengøring** (se s. 39) og vedlagt brochure
-  **Reservedele** (se s. 40)
-  **Godkendelse** (se s. 44)



Montering se s. 31



Avisos de segurança

-  Durante a montagem devem ser utilizadas luvas de protecção, de modo a evitar ferimentos resultantes de entalamentos e de cortes.
-  O sistema de duche só pode ser utilizado para fins de higiene pessoal.
-  Crianças e adultos com deficiências motoras, mentais e/ou sensoriais não podem utilizar o sistema de duche sem monitorização. Pessoas que estejam sob a influência de álcool ou drogas não podem utilizar o sistema de duche.
-  Deve-se evitar o contacto dos jactos de água com partes do corpo sensíveis (p. ex. olhos). É necessário manter uma distância suficiente entre o chuveiro e o corpo.
-  O braço do chuveiro foi concebido apenas para servir de apoio à cabeça do chuveiro, pelo que não pode ser sujeito a cargas de objectos adicionais!

Avisos de montagem

- Antes da montagem deve-se controlar o produto relativamente a danos de transporte.
- A misturadora deve ser instalada, purgada e testada de acordo com as normas em vigor!

Dados Técnicos

Pressão de funcionamento:	max. 0,6 MPa
Pressão de func. recomendada:	0,15 - 0,4 MPa
(1 MPa = 10 bar = 147 PSI)	
Temperatura da água quente:	max. 60°C
Desinfecção térmica:	max. 70°C / 4 min

As misturadoras não são compatíveis com o uso de esquentadores instantâneos hidráulicos, electrónicos ou térmicos.

Este produto foi única e exclusivamente concebido para água potável!

Descrição do símbolo



Meio da base de duche



Água quente



Água fria



Não utilizar silicone que contenha ácido acético!



Nesta zona é necessário um reforço na parede.



Torneira de passagem



Quattro válvula de diversão de 4 vias

Quattro



Trio universal inversor/válvula de corte



Tamponar a saída não utilizada.



Capacidade de escoamento tem que ser superior a 50 l/min.



Escoamento



Medidas (ver página 31)



Fluxograma
(ver página 33)



Funcionamento (ver página 38)



Limpeza (ver página 39) e brochura em anexo



Peças de substituição (ver página 40)







Marca de controlo (ver página 44)



Montagem ver página 31



Wskazówki bezpieczeństwa

-  Aby uniknąć zranień, takich jak zgniecenia czy przecięcia, podczas montażu należy nosić rękawice.
-  Prysznic może być używany tylko w celach kąpieli, higieny i utrzymania czystości ciała.
-  Zarówno dzieci, jak i dorośli z fizycznymi, psychicznymi i/lub sensorycznymi ograniczeniami nie mogą korzystać z prysznica bez opieki. Osoby znajdujące się pod wpływem alkoholu lub narkotyków nie mogą korzystać z prysznica.
-  Należy unikać kontaktu strumienia wypływającego z głowicy z wrażliwymi częściami ciała (np. oczami). Należy zachowywać odpowiednią odległość pomiędzy głowicą a ciałem.
-  Ramię prysznica jest przystosowane do trzymania głowicy prysznica i nie może być obciążane innymi przedmiotami!

Wskazówki montażowe

- Przed montażem należy skontrolować produkt pod kątem szkód transportowych.
- Armatura musi być zamontowana, przepłukana i wypróbowana według obowiązujących norm!

Dane techniczne

Ciśnienie robocze:	maks. 0,6 MPa
Zalecane ciśnienie robocze: (1 MPa = 10 bary = 147 PSI)	0,15 - 0,4 MPa
Temperatura wody gorącej:	maks. 60°C
Dezynfekcja termiczna:	maks. 70°C / 4 min

Armatura Hansgrohe może być wykorzystywana w połączeniu z hydraulicznie, elektronicznie i termicznie sterowanym ogrzewaczem przepływowym.

Produkt stworzono wyłącznie do wody pitnej!

Opis symbolu





-  Środek brodzika
-  Ciepła woda
-  Zimna woda
-  Nie stosować silikonów zawierających kwas octowy!
-  W tym obszarze konieczne jest wzmocnienie ściany.
-  Zawór podtynkowy
-  Regulator czterodrożny Quattro
- Quattro**
-  Zawór odcinający i regulacyjny Trio Universal
- Trio**
-  Niewykorzystany wylot należy zakorkować dołożonym w dostawie korkiem.
-  Wydajność odpływu musi być wyższa niż 50 l/min.
- >50l/min**
-  Odpływ
- Raindrain**
-  **Wymiary** (patrz strona 31)
-  **Schemat przepływu** (patrz strona 33)
-  **Obsługa** (patrz strona 38)
-  **Czyszczenie** (patrz strona 39) i dołączona broszura
-  **Części serwisowe** (patrz strona 40)
-  **Znak jakości** (patrz strona 44)



Montaż patrz strona 31



Bezpečnostní pokyny

-  Pro zabránění řezným zraněním a pohmožděninám je nutné při montáži nosit rukavice.
-  Sprchový systém smí být používán pouze ke koupání a za účelem tělesné hygieny.
-  Děti a dospělé osoby s tělesným, duševním a / nebo smyslovým postižením nesmí sprchový systém používat bez dozoru. Osoby pod vlivem alkoholu nebo drog nesmí sprchový systém používat.
-  Je nutné zabránit kontaktu vodních paprsků sprchy s měkkými částmi těla (např. očima). Je nutné dodržovat dostatečný odstup mezi sprchou a tělem.
-  Držák sprchové hlavice je dimenzován pouze pro držení sprchové hlavice a nesmí se zatěžovat dalšími předměty!

Pokyny k montáži

- Před montáží je třeba produkt zkontrolovat, zda nebyl při transportu poškozen.
- Armatura se musí montovat, proplachovat a testovat podle platných norem!

Technické údaje

Provozní tlak:	max. 0,6 MPa
Doporučený provozní tlak: (1 MPa = 10 bar = 147 PSI)	0,15 – 0,4 MPa
Teplota horké vody:	max. 60 °C
Tepelná desinfekce:	max. 70 °C / 4 min

Tento produkt nemůže být používán ve spojení s hydraulicky a teplotně řízenými průtokovými ohřivači.

Výrobky Hansgrohe jsou vhodné pro přímý kontakt s pitnou vodou.

Popis symbolů



Střed sprchové vany



Teplá voda



Studená voda



Nepoužívat silikon s obsahem kyseliny octové!



V této oblasti je potřebné zesílení stěny.



Podomítkový uzavírací ventil



Quattro čtyřcestné přestavování

Quattro



Trio Universal - Uzavírací a přepínací ventil



Nepoužitý vývod musí být utěsněn zaslepovací zátkou.



Odtokový výkon musí být vyšší než 50 l/min.



Odtok



Rozměry (viz strana 31)



Diagram průtoku
(viz strana 33)



Ovládání (viz strana 38)



Čištění (viz strana 39) a přiložená brožura



Servisní díly (viz strana 40)



Zkušební značka (viz strana 44)



Montáž viz strana 31



Bezpečnostné pokyny

- ⚠ Pri montáži musíte nosiť rukavice, aby ste predišli pomliaždeninám a rezným poraneniam.
- ⚠ Sprchovací systém sa smie používať len na kúpanie a telesnú hygienu.
- ⚠ Sprchovací systém nesmú bez dozoru používať deti, ako aj dospelé osoby s telesným, duševným a/alebo zmyslovým postihnutím. Sprchovací systém nesmú používať ani osoby, ktoré sú pod vplyvom alkoholu alebo drog.
- ⚠ Vyhýbajte sa kontaktu vodného lúča sprchy s citlivými miestami tela (napr. oči). Dodržiavajte dostatočnú vzdialenosť medzi sprchou a telom.
- ⚠ Rameno držiaka hlavice sprchy je určené len na uchytenie hlavice sprchy a nesmie sa zaťažovať inými predmetmi!

Pokyny pre montáž

- Pred montážou musíte produkt skontrolovať, či nebol počas transportu poškodený.
- Batéria sa musí montovať, preplachovať a testovať podľa platných noriem!

Technické údaje

Prevádzkový tlak:	max. 0,6 MPa
Doporučený prevádzkový tlak: (1 MPa = 10 bar = 147 PSI)	0,15 – 0,4 MPa
Teplota teplej vody:	max. 60 °C
Termická dezinfekcia:	max. 70 °C / 4 min

Tento produkt sa nesmie používať v spojení s hydraulicky a teplotne riadenými prietokovými ohrievačmi.

Výrobok je koncipovaný výhradne pre pitnú vodu!

Popis symbolov

-  Stred sprchovej vane
-  Teplá voda
-  Studená voda
-  Nepoužívať silikón s obsahom kyseliny octovej!
-  V tejto oblasti je potrebné zosilnenie steny.
-  Podomietkový uzatvárací ventil
-  Quattro štvorcestné prestavenie
-  Trio univerzálny uzatvárací a prestavovací ventil
-  Trio
-  Nepoužitý vývod musí byť zaslepený zátkou.
-  Výkon odtoku musí byť vyšší ako 50 l/min.
-  Odtok
-  Rain drain
-  **Rozmery** (viď strana 31)
-  **Diagram prietoku** (viď strana 33)
-  **Obsluha** (viď strana 38)
-  **Čistenie** (viď strana 39) a priložená brožúra
-  **Servisné diely** (viď strana 40)
-  **Osvedčenie o skúške** (viď strana 44)



Montáž viď strana 31



安全技巧

- △ 装配时为避免挤压和切割受伤，必须戴上手套。
- △ 淋浴系统只允许作为洗浴、卫生和洁身之用。
- △ 不得让儿童和肢体、精神和/或意识有障碍的成人在不受监管的情况下使用淋浴系统。受酒精或毒品影响的人员不得使用淋浴系统。
- △ 必须避免让身体敏感部位（如眼睛）接触到莲蓬头喷水。必须保持莲蓬头与人头之间有足够的距离。
- △ 头顶莲蓬头夹持杆只为夹持头顶莲蓬头而设计，不得让其承载其它物品！

安装提示

- 安装前必须检查产品是否受到运输损害。
- 必须按照现行的规定安装，冲洗和测试产品！



















技术参数

工作压强: 最大 0,6 MPa
 推荐工作压强: 0,15 0,4 MPa
 (1 MPa = 10 bar = 147 PSI)
 热水温度: 最大 60° C
 热力消毒: 最大 70° C / 4 分钟

该产品不可与液控和热控即热式热水器连接使用。

该产品专为饮用水设计！

符号说明





-  中心淋浴盆
-  热水
-  冷水
-  请勿使用含有乙酸的硅！
-  该区域需要一个加固边壁。
-  截止阀
-  Quattro 四通转换器
-  **Quattro**
-  通用的三通截止阀和换向阀
-  **Trio**
-  插入不使用的插座。
-  排水功率必须大于 50 l/min。
-  排水口
-  大小 (参见第 31 页)
-  流量示意图 (参见第 33 页)
-  操作 (参见第 38 页)
-  清洗 (参见第 39 页) 并附有小手册
-  备用零件 (参见第 40 页)
-  检验标记 (参见第 44 页)



安装 参见第 31 页



Указания по технике безопасности

-  Во время монтажа следует надеть перчатки во избежание прищемления и порезов.
-  Душевую систему разрешается использовать только в гигиенических целях для принятия ванны и личной гигиены.
-  Дети, а также взрослые с физическими, умственными и/или сенсорными недостатками должны пользоваться душевой системой только под присмотром. Запрещается пользоваться душевой системой в состоянии алкогольного или наркотического опьянения.
-  Не допускайте попадания струи воды из разбрызгивателя на чувствительные части тела (например, на глаза). Разбрызгиватель следует устанавливать на достаточном расстоянии от тела.
-  Кронштейн верхнего душа предназначен только для подсоединения верхнего душа. Запрещается подвешивать на него другие предметы!

Указания по монтажу

- Перед монтажом следует проверить изделие на предмет повреждений при перевозке.
- Смеситель должен быть смонтирован по действующим нормам и в соответствии с настоящей инструкцией, проверен на герметичность и безупречность работы

Технические данные

















Рабочее давление: не более 0,6 МПа
 Рекомендуемое рабочее давление: 0,15 – 0,4 МПа
 (1 МПа = 10 bar = 147 PSI)

Температура горячей воды: не более 60 °С
 Термическая дезинфекция: не более 70 °С / 4 мин

Применение этой продукции при наличии гидравлических и проточных нагревателей с тепловой регулировкой не допускается.

Изделие предназначено исключительно для питьевой воды!





Описание символов

-  Середина душевой ванны
-  Теплая вода
-  Холодная вода
-  Не применяйте силикон, содержащий уксусную кислоту.
-  В этой области требуется укрепление стены.
-  Скрытый вентиль
-  Четырехходовой переключатель Quattro
- Quattro**
-  Трехходовой запорный и переключающий вентиль Trio Universal
- Trio**
-  Ненужный выход необходимо уплотнить с помощью заглушки.
-  Слив должен иметь производительность более 50 л/мин.
- >50l/min**
-  Слив
- Raindrain**
-  **Размеры** (см. стр. 31)
-  **Схема потока** (см. стр. 33)
-  **Эксплуатация** (см. стр. 38)
-  **Очистка** (см. стр. 39) и прилагаемая брошюра
-  **Комплект** (см. стр. 40)
-  **Знак технического контроля** (см. стр. 44)





Biztonsági utasítások

-  A szerelésnél a zúzódások és vágási sérülések elkerülése érdekében kesztyűt kell viselni.
-  A zuhanyrendszert csak fürdéshez, mosakodáshoz és egészségügyi tisztálkodáshoz szabad használni.
-  Gyermekek, valamint testileg, szellemileg fogyatékos vagy érzékelésben korlátozott személyek nem használhatják felügyelet nélkül a zuhanyrendszert. Alkohol és kábítószer befolyása alatt álló személyek nem használhatják a zuhanyrendszert.
-  Kerülni kell a zuhansugár érintkezését érzékeny testrészekkel (pl. szemek). Be kell tartani a megfelelő távolságot a zuhanyfej és a test között.
-  A zuhanyfej karja csak a zuhanyfej tartására alkalmas, és nem szabad más tárggyal megterhelni!

Szerelési utasítások

- A szerelés előtt ellenőrizni kell, hogy a terméknek nincs-e szállítási sérülése.
- A csaptelepet az érvényben lévő előírásoknak megfelelően kell felszerelni, átöblíteni és ellenőrizni!

Műszaki adatok

Üzemi nyomás:	max. 0,6 MPa
Ajánlott üzemi nyomás: (1 MPa = 10 bar = 147 PSI)	0,15 – 0,4 MPa
Forróvíz hőmérséklet:	max. 60 °C
Termikus fertőtlenítés:	max. 70 °C / 4 perc

Ha a zuhany működik, akkor ennek a zuhanykarral együtt kb. 10 kg a tömege. Ezért csak a falnak megfelelő rögzítő anyagot szabad használni! A mellékelt csavarok és tiplik csak tömör falakhoz használhatók.

A terméket kizárólag ivóvízhez tervezték!

Szimbólumok leírása



Zuhanytálca közepe



Melegvíz



Hidegvíz



Ne használjon ecetsavtartalmú szilikon!



Ezen a területen a fal megerősítésére van szükség.



Falsík alatti szelep



Quattro négy-utas átalakító

Quattro



Trio univerzális záró- és váltószelep

Trio



A főlősleges kimenetet vakdugóval kell lezárni.



A lefolyó teljesítményének 50l/percnél magasabbnak kell lenni



Lefolyó



Méretet (lásd a 31. oldalon)



Átfolyási diagramm
(lásd a 33. oldalon)



Használat (lásd a 38. oldalon)



Tisztítás (lásd a 39. oldalon) és mellékelt bróssúrával



Tartozékok (lásd a 40. oldalon)



Vizsgajel (lásd a 44. oldalon)



Szerelés lásd a 31. oldalon



Turvallisuusohjeet

- ⚠ Asennuksessa on käytettävä käsineitä puristumien ja viiltojen aiheuttamien tapaturmien estämiseksi.
- ⚠ Suihkujärjestelmää saa käyttää ainoastaan kylpy-, hygienia- ja puhdistustarkoituksiin.
- ⚠ Lapset ja ruumiillisesti, henkisesti ja/tai aistillisesti rajoittuneet aikuiset eivät saa käyttää suihkujärjestelmää ilman valvontaa. Alkoholin tai huumeiden vaikutuksessa olevat henkilöt eivät saa käyttää suihkujärjestelmää.
- ⚠ Suihkuveden kontaktia herkkien ruumiinosien (esim. silmien) kanssa on vältettävä. Suihkun ja vartalon välissä on oltava riittävä väli.
- ⚠ Pääsuihkun varsi on tarkoitettu vain kannattamaan pääsuihkua. Sitä ei saa kuormittaa muilla esineillä!

Asennusohjeet

- Ennen asennusta on tarkastettava tuotteen mahdolliset kuljetusvahingot.
- Kaluste on asennettava, huuhdeltava ja tarkastettava voimassa olevien määräysten mukaisesti!

Tekniset tiedot

Käyttöpaine:	maks. 0,6 MPa
Suosittelut käyttöpaine:	0,15 – 0,4 MPa
(1 MPa = 10 bar = 147 PSI)	
Kuuman veden lämpötila:	maks. 60 °C
Lämpödesinfektio:	maks. 70 °C / 4 min

Tätä tuotetta ei voi käyttää hydraulisesti tai termisesti ohjattujen läpivirtauskuumentimien yhteydessä.

Tuote on suunniteltu käytettäväksi ainoastaan juomaveden kanssa!

Merkin kuvaus



Suihkultaan keskusta



Lämmin vesi



Kylmä vesi



Älä käytä etikkahappopitoista silikonia!



Tässä kohdassa seinää on vahvistettava



Upotettava venttiili



4-tiesäätöventtiili

Quattro



Trio -sulku- ja säätöventtiili



Käyttömätön lähtöliitin on suljettava sulku-tulpalla.



Poisvirtaustehon on oltava enemmän kuin 50l/min.



Veden poisvirtaus

Raindrain



Mitat (katso sivu 31)



Virtausdiagrammi (katso sivu 33)



Käyttö (katso sivu 38)



Puhdistus (katso sivu 39) ja oheinen esite



Varaosat (katso sivu 40)







Koestusmerkki (katso sivu 44)



Asennus katso sivu 31



Säkerhetsanvisningar

-  Handskar ska bäras under monteringsarbetet så att man kan undvika kläm- och skärskadorgen werden.
-  Duschsystemet får bara användas till kroppshygien med bad och dusch.
-  Barn samt vuxna med fysiska, psykiska eller sensoriska funktionshinder får inte använda duschsystemet ensamma. Personer som är påverkade av alkohol- eller droger får inte använda duschsystemet.
-  Undvik att rikta duschstrålarna mot känsliga kroppsdelar (t. ex. ögonen). Det måste finnas ett tillräckligt stort avstånd mellan duschen och kroppen.
-  Armen som håller huvudduschen är bara konstruerad för detta; den får inte belastas med andra föremål!

Monteringsanvisningar

- Det måste undersökas om produkten har transportskador innan den monteras.
- Blandaren måste installeras, genomspolas och testas enligt gällande föreskrifter.

Tekniska data

Driftstryck:	max. 0,6 MPa
Rek. driftstryck:	0,15 – 0,4 MPa
(1 MPa = 10 bar = 147 PSI)	
Varmvattentemperatur:	max. 60 °C
Termisk desinfektion:	max. 70 °C / 4 min

Denna produkt kan inte användas tillsammans med hydrauliskt och termiskt styrda varmvattenberedare.

Produkten är enbart avsedd för dricksvatten!

Symbolförklaring



Mitten av duschkaret



Varmvatten



Kallvatten



Använd inte silikon som innehåller ättiksyra!



Šioje zonoje būtinas sienos sutvirtinimas



Invändig ventil



Quattro Fyrvägsomkastare

Quattro



Trio Universell avstängningsventil och omkastare



Det utlopp som inte behövs måste tätas med en blindstopp.



Avloppet måste klara mer än 50 l/min.



Avlopp



Måtten (se sidan 31)



Flödesschema
(se sidan 33)



Hantering (se sidan 38)



Rengöring (se sidan 39) och medföljande broschyr



Reservdelar (se sidan 40)



Testsigill (se sidan 44)



Montering se sidan 31



Saugumo technikos nurodymai

- ⚠️ Apsaugai nuo užspaudimo ir įsijovimo montavimo metu mūvėkite pirštines.
- ⚠️ Dušo sistema turi būti naudojama tik kūno higienai ir švarai palaikyti.
- ⚠️ Dušo sistema uždrausta naudotis vaikams, taip pat suaugusiems su fizine, dvasine negale ir (arba) sensorikos sutrikimais. Dušo sistema taip pat uždrausta naudotis asmenims, apsvaigusiems nuo alkoholio arba narkotikų.
- ⚠️ Būtina vengti dušo vandens srovės kontakto su jautriomis kūno vietomis (pvz., akimis). Todėl būtina laikytis tinkamo atstumo nuo dušo.
- ⚠️ Dušo laikiklis skirtas tik dušo galvutei laikyti, todėl neturi būti apkraunamas kitokiais daiktais!

Montavimo instrukcija

- Prieš montuojant būtina patikrinti, ar gaminyje nebuvo pažeistas transportavimo metu.
- Maišytuvą privalo būti montuojamas, išleidžiamas ir patikrinamas pagal galiojančias normas!



















Techniniai duomenys

Darbinis slėgis: ne daugiau kaip 0,6 MPa
 Rekomenduojamas slėgis: 0,15 – 0,4 MPa
 (1 MPa = 10 barų = 147 PSI)
 Karšto vandens temperatūra: ne daugiau kaip 60 °C
 Terminis dezinfekavimas: ne daugiau kaip 70 °C / 4 min

Šio produkto negalima naudoti kartu su hidrauliškai ir termiškai valdomu tekančio vandens šildytuvu.

Produktas skirtas tik geriamajam vandeniui!





Simbolio aprašymas

-  Dušo padėklo centras
-  Šiltas vanduo
-  Šaltas vanduo
-  Nenaudokite silikono, kurio sudėtyje yra acto rūgšties!
-  Šioje zonoje būtinas sienos sutvirtinimas
-  Potinkinis uždarymo vožtuvas
-  „Quattro“ 4-krypčių perjungimas
-  Užtvarinis ir perjungimo vožtuvas „Trio Universal“
-  Nenaudojamą išėjimą užaklinti.
-  Nutekėjimo našumas turi būti ne mažesnis 50 l/min
-  Nutekėjimas
-  **Raindrain**
-  **Išmatavimai** (žr. psl. 31)
-  **Pralaidumo diagrama** (žr. psl. 33)
-  **Eksplotacija** (žr. psl. 38)
-  **Valymas** (žr. psl. 39) ir pridama brošiūra
-  **Atsarginės dalys** (žr. psl. 40)
-  **Bandyimo pažyma** (žr. psl. 44)





Sigurnosne upute

-  Prilikom montaže se radi sprječavanja prignječenja i posjekotina moraju nositi rukavice.
-  Sustav tuša se smije primjenjivati samo za kupanje, tuširanje i osobnu higijenu.
-  Djeca, kao i tjelesno, mentalno i/ili senzorno hendikepirane odrasle osobe ne smiju se koristiti sustavom tuša bez nadzora. Osobe koje su pod utjecajem alkohola ili droga ne smiju se koristiti sustavom tuša.
-  Mora se izbjegavati kontakt mlaza iz tuša s osjetljivim dijelovima tijela (npr. očima). Tijelo korisnika mora biti dovoljno udaljeno od tuša.
-  Nosač tuša iznad glave je dimenzioniran samo za držanje danog tuša i ne smije se opterećivati drugim predmetima!

Upute za montažu

- Prije montaže mora se provjeriti je li proizvod oštećen prilikom transporta.
- Cijevi moraju biti postavljene, isprane i testirane prema važećim normama!

















Tehnički podaci

Najveći dopušteni tlak:	tlak 0,6 MPa
Preporučeni tlak:	0,15 – 0,4 MPa
(1 MPa = 10 bar = 147 PSI)	
Temperatura vruće vode:	tlak 60 °C
Termička dezinfekcija:	tlak 70 °C / 4 min

Ovaj proizvod se ne može rabiti uz hidraulički i termički regulirane protočne bojlere.

Proizvod je koncipiran isključivo za pitku vodu!

Opis simbola

-  Sredina tuš-kada
-  Topla voda
-  Hladna voda
-  Nemojte koristiti silikon koji sadrži octenu kiselinu!
-  U ovom je području potrebno ojačanje zida.
-  Podžbukni ventil
-  Quattro četverostruki preusmjerač
-  Trio Universal ventil za zatvaranje i ventil selektora
-  Potrebno je ostaviti zatvoren izlaz koji se ne koristi
-  Protok vode mora biti veći od 50 l/min.
-  Odvod
-  **Mjere** (pogledaj stranicu 31)
-  **Dijagram protoka** (pogledaj stranicu 33)
-  **Upotreba** (pogledaj stranicu 38)
-  **Čišćenje** (pogledaj stranicu 39) i priložena brošura
-  **Rezervni dijelovi** (pogledaj stranicu 40)
-  **Oznaka testiranja** (pogledaj stranicu 44)



Sastavljanje pogledaj stranicu 31



! Güvenlik uyarıları

- ⚠ Montaj esnasında ezilme ve kesilme gibi yaralanmaları önlemek için eldiven kullanılmalıdır.
- ⚠ Duş sistemi yalnızca banyo, hijyen ve beden temizliği amaçları doğrultusunda kullanılabilir.
- ⚠ Bedensel, ruhsal ve/veya sensörük engelli çocuk ve yetişkinler gözetimsiz olarak duş sistemini kullanmamalıdır. Alkol veya uyuşturucu etkisinde olanlar duş sistemini kullanmamalıdır.
- ⚠ Püskürtme başlıklarının hassas organlara teması (örn. gözler) önlenmelidir. Püskürtücü ile beden arasında yeterli mesafe bırakılmalıdır.
- ⚠ Başlıklı püskürtücü kolu yalnızca başlıklı püskürtücünün tutulması için tasarlanmıştır, başka nesnelere üzerine yük bindirilmemelidir!

Montaj açıklamaları

- Montaj işleminden önce ürün nakliye hasarları yönünden kontrol edilmelidir.
- Batarya geçerli normlara göre monte edilmeli, yıkanmalı ve kontrol edilmelidir!

Teknik bilgiler

İşletme basıncı: azami 0,6 MPa
Tavsiye edilen işletme basıncı: 0,15 - 0,4 MPa
(1 MPa = 10 bar = 147 PSI)
Sıcak su sıcaklığı: azami 60 °C
Termik dezenfeksiyon: azami 70 °C / 4 dak

Bu ürün hidrolik ve termik kumandalı akış ısıtıcılarıyla bağlantılı olarak kullanılmamalıdır.

Ürün sadece şebeke suyu için tasarlanmıştır!

Simge açıklaması



Duş küvetinin ortası



Sıcak su



Soğuk su



Asetik asit içeren silikon kullanmayın!



Bu alanda duvarın kalınlaştırılması gereklidir.



Sıva altı valfi



Quattro dört yönlü değiştirme

Quattro



Trio üniversal kapatma ve değiştirme valfi



Kullanılmayan çıkış bir kör tapayla izole edilmelidir.



>50l/min

Akış kapasitesi 50 l/dak üzerinde olmalıdır.



Rain drain

Akış



Ölçüleri (Bakınız sayfa 31)



Akış diyagramı
(Bakınız sayfa 33)



Kullanımı (Bakınız sayfa 38)



Temizleme (Bakınız sayfa 39) ve birlikte verilen broşür



Yedek Parçalar (Bakınız sayfa 40)







Kontrol işareti (Bakınız sayfa 44)



Montajı Bakınız sayfa 31



Instrucțiuni de siguranță

-  La montare utilizați mănuși pentru evitarea contuziunilor și tăierii mâinilor.
-  Sistemul de duș poate fi utilizat doar pentru spălarea, menținerea igienei și curățarea corpului.
-  Copiii și adulții cu dizabilități corporale, mintale și senzoriale nu pot utiliza sistemul de duș nesupravegheați. De asemenea este interzisă utilizarea sistemului de duș de către persoane, care se află sub influența alcoolului sau a drogurilor.
-  Evitați contactul jetului de apă cu părțile de corp sensibile (de ex. ochii). Țineți dușul la o distanță corespunzătoare de corp.
-  Brațul parei de duș este destinat doar pentru a susține para, acesta nu poate fi prevăzut cu alte obiecte.

Instrucțiuni de montare

- Înainte de instalare verificați, dacă produsul prezintă deteriorări de transport.
- Bateria trebuie montată, clătită și verificată conform normelor în vigoare.

Date tehnice

Presiune de funcționare:	max. 0,6 MPa
Presiune de funcționare recomandată:	0,15 – 0,4 MPa (1 MPa = 10 bar = 147 PSI)
Temperatura apei calde:	max. 60 °C
Dezinfecție termică:	max. 70 °C / 4 min

Acest produs nu poate fi utilizat în combinație cu boilere cu flux continuu hidraulice sau comandate termic.

Produsul este destinat exclusiv pentru apă potabilă.

Descrierea simbolurilor



În mijlocul căzii de duș



Apă caldă



Apă rece



Nu utilizați silicon cu conținut de acid acetic!



În această zonă este nevoie de întărirea peretelui.



Ventil montat sub tencuială



Quattro valvă de inversare cu patru căi

Quattro



Trio valvă de închidere și de inversare universală



Racordurile neutilizate trebuie acoperite cu dop etanș.



Capacitatea de evacuare trebuie să fie mai mare de 50 l/min.



Deversor



Dimensiuni (vezi pag. 31)



Diagrama de debit
(vezi pag. 33)



Utilizare (vezi pag. 38)



Curățare (vezi pag. 39) și broșura alăturată



Piese de schimb (vezi pag. 40)



Certificat de testare
(vezi pag. 44)



Montare vezi pag. 31



Υποδειξεις ασφαλείας

- ⚠ Για να αποφύγετε τραυματισμούς κατά τη συναρμολόγηση πρέπει να φοράτε γάντια.
- ⚠ Το σύστημα ντους επιτρέπεται να χρησιμοποιείται μόνο σαν μέσο λουτρού, υγιεινής και καθαρισμού του σώματος.
- ⚠ Παιδιά ή ενήλικες με μειωμένες σωματικές, διανοητικές και/ή αισθητήριες ανεπάρκειες δεν επιτρέπεται να χρησιμοποιούν το σύστημα ντους χωρίς επιτήρηση. Άτομα υπό την επήρεια οινοπνεύματος ή ναρκωτικών δεν επιτρέπεται να χρησιμοποιούν σε καμία περίπτωση το
- ⚠ Η επαφή δέσμης νερού του ντους με ευαίσθητες περιοχές του σώματος (π.χ. μάτια) πρέπει να αποφεύγεται. Διατηρείτε επαρκή απόσταση ανάμεσα στο ντους και το σώμα.
- ⚠ Ο βραχιόνιας του ντους κεφαλιού έχει μελετηθεί μόνο για να κρατά το ντούς κεφαλιού, δεν επιτρέπεται να φορτίζεται με άλλα αντικείμενα!

Οδηγίες συναρμολόγησης

- Πριν τη συναρμολόγηση πρέπει να εξεταστεί το προϊόν για ζημιές μεταφοράς.
- Η κεντρική βάνα πρέπει να τοποθετηθεί, να πλυθεί και να ελεγχθεί με βάση τους ισχύοντες κανόνες υδραυλικής τέχνης!

















Τεχνικά Χαρακτηριστικά

Λειτουργία πίεσης:	έως 0,6 MPa
Συνιστώμενη λειτουργία πίεσης:	0,15 - 0,4 MPa
(1 MPa = 10 bar = 147 PSI)	
Θερμοκρασία ζεστού νερού:	έως 60 °C
Θερμική απολύμανση:	έως 70 °C / 4 min

Αυτό το προϊόν δεν μπορεί να χρησιμοποιηθεί σε συνδυασμό με υδραυλικούς και θερμικά ελεγχόμενους ταχυθερμοσίφωνες.

Το προϊόν έχει σχεδιαστεί αποκλειστικά για πόσιμο νερό!





Περιγραφή συμβόλων

-  Μέσον της ντουσιέρας
-  Ζεστό νερό
-  Κρύο νερό
-  Μην χρησιμοποιείτε σιλικόνη που περιέχει οξικό οξύ!
-  Σε αυτήν την περιοχή είναι απαραίτητη μία ενίσχυση του τοίχου.
-  Χωνευτή βαλβίδα
-  Quattro τετράοδης μετατροπής
- Quattro**
-  Trio Universal βαλβίδα κλεισίματος και εκτροπής
- Trio**
-  Τα περιττά στόμια εξόδου πρέπει να στεγανοποιηθούν με ένα τυφλό πώμα.
-  Η αποχετευτική ικανότητα της βαλβίδας εκροής πρέπει να υπερβαίνει τα 1/min.
- >50l/min**
-  Βαλβίδα εκροής
- Raindrain**
-  **Διαστάσεις** (βλ. σελίδα 31)
-  **Διάγραμμα ροής** (βλ. σελίδα 33)
-  **Χειρισμός** (βλ. σελίδα 38)
-  **Καθαρισμός** (βλ. σελίδα 39) και συνημμένο φυλλάδιο
-  **Ανταλλακτικά** (βλ. σελίδα 40)
-  **Σήμα ελέγχου** (βλ. σελίδα 44)





Varnostna opozorila

-  Lors du montage, porter des gants de protection pour éviter toute blessure par écrasement ou coupure.
-  Sistem za prhanje se sme uporabljati le z namenom umivanja, vzdrževanja higiene in telesne nege.
-  Otroci kot tudi odrasle osebe z omejenimi telesnimi, duševnimi in/ali senzoričnimi sposobnostmi ne smejo nenadzorovano uporabljati sistema za prhanje. Osebe, ki so pod vplivom alkohola ali drog, sistema za prhanje ne smejo uporabljati.
-  Izogibati se je treba stiku prhalnega curka z občutljivimi deli telesa (npr. očmi). Med telesom in prho mora biti vedno zadosten razmik.
-  Nosilna roka naglavne prhe je konstruirana le za nošenje prhe in je ne smete obremeniti z drugimi predmeti!

Navodila za montažo

- Pred montažo je treba izdelek preveriti glede morebitnih transportnih poškodb.
- Armaturo je potrebno montirati, sprati in testirati v skladu z veljavnimi normami!

















Tehnični podatki

Delovni tlak:	maks. 0,6 MPa
Priporočeni delovni tlak: (1 MPa = 10 bar = 147 PSI)	0,15 - 0,4 MPa
Temperatura tople vode:	maks. 60°C
Termična dezinfekcija:	maks. 70°C / 4 min

Tega proizvoda ni možno uporabiti v povezavi s hidravlično in termično krmiljenimi pretočnimi grelniki.

Proizvod je zasnovan izključno za sanitarno vodo!

Opis simbola





-  Sredina pršne kadi
-  Topla voda
-  Mrzla voda
-  Ne smete uporabiti silikona, ki vsebuje očetno kislino!
-  V tem območju je potrebno ojačanje stene.
-  Podometni ventil
-  Quattro ütiripotna prestavitev
- Quattro**
 Trio Universal zaporni in preklopni ventil
- Trio**
 Izhod, ki ga ne potrebujete, zatesnite s čepom.
-  Odtočna kapacitetamora znašati več kot 50 l/min.
-  Odtok
-  **Mere** (glejte stran 31)
-  **Diagram pretoka** (glejte stran 33)
-  **Upravljanje** (glejte stran 38)
-  **Čiščenje** (glejte stran 39) in priložena brošura
-  **Rezervni deli** (glejte stran 40)
-  **Preskusni znak** (glejte stran 44)



Montaža Glejte stran 31.



Ohutusjuhised

-  Kandke paigaldamisel muljumis- ja löikevigastuste vältimiseks kindaid.
-  Dušisüsteemi tohib kasutada ainult pesemis-, hügieeni- ja kehapihustamiseesmärkidel.
-  Lapsed, samuti kehaliste, vaimsete või tajupiirangutega täiskasvanud ei tohi dušisüsteemi järelevalveta kasutada. Alkoholi või narkootikumide mõju all olevad isikud ei tohi dušisüsteemi kasutada.
-  Duši veejoad ei tohi kokku puutuda tundlike kehaosadega (nt silmad). Jätke duši ja keha vahele piisav vahe.
-  Duši pea hoidik on mõeldud ainult duši pea hoidmiseks ja seda ei tohi muude esemetega koormata!

Paigaldamisjuhised

- Enne paigaldamist tuleb toodet kontrollida transpordikahjustuste osas
- Segisti paigaldamine, loputamine ja kontroll peab toimuma vastavalt kehtivatele normidele!

Tehnilised andmed

Töörõhk	maks. 0,6 MPa
Soovitatav töörõhk:	0,15 – 0,4 MPa
(1 MPa = 10 baari = 147 PSI)	
Kuuma vee temperatuur:	maks. 60 °C
Termiline desinfitatsioon:	maks. 70 °C / 4 min

Seda toodet ei saa kasutada koos hüdrauliliselt ja termiliselt juhitava läbivoolusoojendiga.

Toode on ette nähtud eranditult joogivee jaoks!

Sümbolite kirjeldus



Dušivanni kese



Soe vesi



Külm vesi



Ärge kasutage äädikhapet sisaldavat silikooni!



Selles alas tuleb seina tugevdada.



peiteklapp



Quattro-liitmik

Quattro



Katkestus- ja ümberlülituskapp Trio Universal

Trio



Mittevajalik väljavool tuleb sulgeda korgiga.



>50l/min

Äravoolu jõudlus peab olema suurem kui 50 l/min.



Raindrain

Äravoole



Mõõtude (vt lk 31)



Läbivooludiagramm
(vt lk 33)



Kasutamine (vt lk 38)



Puhastamine (vt lk 39) ja kaasas olev brošüür



Varuosad (vt lk 40)







Kontrollsertifikaat (vt lk 44)





Drošības norādes

-  Montāžas laikā, lai izvairītos no saspiedumiem un iegriezumiem, nepieciešams nēsāt cimdus.
-  Šo dušas sistēmu drīkst izmantot tikai, lai mazgātos, higiēnai un ķermeņa tīrīšanai.
-  Bērni, kā arī pieaugušie ar fiziskiem, garīgiem un / vai sensoriskiem ierobežojumiem nedrīkst lietot šo dušas sistēmu bez uzraudzības. Personas, kas atrodas alkohola vai narkotisko vielu iespaidā, nedrīkst lietot šo dušas sistēmu.
-  Nepieciešams izvairīties no dušas strūkļas tieša kontakta ar jutīgām ķermeņa daļām (piem., acīm). Nepieciešams ievērot pietiekošu attālumu starp dušu un ķermeni.
-  Galvas dušas statīvs paredzēts vienīgi galvas dušas atbalstīšanai, to nedrīkst noslogot ar citiem priekšmetiem!

Norādījumi montāžai

- Pirms montāžas nepieciešams pārbaudīt, vai produktam transportēšanas laikā nav radušies bojājumi.
- Armatūra jāuzstāda, jāizskalo un jāpārbauda atbilstoši spēkā esošajām normām!

















Tehniskie dati

Darba spiediens:	maks. 0,6 MPa
ļeteicamais darba spiediens: (1 MPa = 10 bar = 147 PSI)	0,15 – 0,4 MPa
Karstā ūdens temperatūra:	maks. 60°C
Termiskā dezinfekcija:	maks. 70°C / 4 min

Šo izstrādājumu nevar uzstādīt kopā ar hidrauliski un termiski vadītu caurplūdes sildītāju.

Izstrādājums ir paredzēts tikai dzeramajam ūdenim!

Simbolu nozīme

-  Dušas paliktņa vidus
-  Siltais ūdens
-  Aukstais ūdens
-  Neizmantot silikonu, kas satur etiķskābi!
-  Šajā zonā ir nepieciešams pastiprināt sienu.
-  Zemapmetuma ventilis
-  Četrvirzienu pārslēgs
- Quattro**
-  Trīsvirzienu universālais noslēgvārsts un pārslēdzējvārsts
- Trio**
-  Neizmantoto izteku aizbāzt ar aizbāzni.
-  Noteces veiktspējai jābūt vairāk nekā 50 l/min.
-  Notece
-  **Izmērus** (skat. 31. lpp.)
-  **Caurplūdes diagramma** (skat. 33. lpp.)
-  **Lietošana** (skat. 38. lpp.)
-  **Tīrīšana** (skat. 39. lpp.) un klāt pievienotais buklets
-  **Rezerves daļas** (skat. 40. lpp.)
-  **Pārbaudes zīme** (skat. 44. lpp.)



Montāža skat. 31. lpp.



Sigurnosne napomene

- ⚠ Prilikom montaže se radi sprečavanja prignječenja i posekotina moraju nositi rukavice.
- ⚠ Sistem tuša sme da se koristi samo za kupanje, tuširanje i ličnu higijenu.
- ⚠ Deca, kao i telesno, mentalno i/ili senzorno hendikepirane odrasle osobe ne smeju da koriste sistem tuša bez nadzora. Osobe koje su pod uticajem alkohola ili droga ne smeju da koriste sistem tuša.
- ⚠ Mora se izbegavati kontakt mlaza iz tuša sa osetljivim delovima tela (npr. očima). Telo korisnika mora biti na dovoljnom odstojanju od tuša.
- ⚠ Nosач tuša iznad glave je dimenzioniran samo za držanje datog tuša i ne sme se opterećivati drugim predmetima!

Instrukcije za montažu

- Pre montaže se mora proveriti da li je proizvod oštećen pri transportu.
- Armatura mora biti postavljena, isprana i testirana prema važećim normama!











Tehnički podaci

Radni pritisak:	maks. 0,6 MPa
Preporučeni radni pritisak:	0,15 – 0,4 MPa
(1 MPa = 10 bar = 147 PSI)	
Temperatura vruće vode:	maks. 60 °C
Termička dezinfekcija:	maks. 70 °C / 4 min

Ovaj proizvod se ne može koristiti uz hidraulički i termički regulisane protočne bojlere.

Proizvod je koncipiran isključivo za pijaću vodu!

Opis simbola





-  Sredina tuš-kada
-  Topla voda
-  Hladna voda
-  Nemojte koristiti silikon koji sadrži sirćetnu kiselinu!
-  U ovoj oblasti je potrebno ojačanje zida.
-  Uzidni ventil
-  Quattro četverostruki preusmerivač
-  Trio Universal ventil za zatvaranje i preklopni ventil
-  Trio
-  Izlaz koji se ne koristi, mora se zatvoriti slepim čepom.
-  Kapacitet odvoda mora biti veći od 50 l/min.
-  Ispust
-  Raindrain
-  **Mere** (vidi stranu 31)
-  **Dijagram protoka** (vidi stranu 33)
-  **Rukovanje** (vidi stranu 38)
-  **Čišćenje** (vidi stranu 39) i priložena brošura
-  **Rezervni delovi** (vidi stranu 40)
-  **Ispitni znak** (vidi stranu 44)



Montaža vidi stranu 31



Sikkerhetshenvisninger

-  Bruk hansker under montasjen for å unngå klem- og kuttskader.
-  Dusjsystemet skal kun brukes for bade-, hygiene- og kroppsurengjøringsformål.
-  Barn og voksne med fysiske og psykiske og/eller sensoriske handicap skal ikke bruke dusjsystemet uten oppsyn. Personer som er påvirket av alkohol eller narkotika skal ikke bruke dusjsystemet.
-  Dusjstrålen skal ikke komme i kontakt med ømfintlige kroppsdeler (f.eks. øynene). Overhold en tilstrekkelig avstand mellom dusjen og kroppen.
-  Armen til hodedusjen er kun laget for å holde hodedusjen. Den må ikke belastes med andre gjenstander!

Montagehenvisninger

- Før montasjen skal produktet sjekkes for transportskader.
- Armaturen skal monteres iht. gyldige standarder. De skal spyles og sjekkes!

Tekniske data

Driftstrykk	maks. 0,6 MPa
Anbefalt driftstrykk: (1 MPa = 10 bar = 147 PSI)	0,15 – 0,4 MPa
Varmtvannstemperatur	maks. 60 °C
Termisk desinfisering:	maks. 70 °C / 4 min

Dette produktet kan ikke brukes i forbindelse med hydraulisk og termisk styrte gjennomstrømningsovner.

Produktet er utelukkende designet for drikkevann!

Symbolbeskrivelse



Midten på dusjkar



Varmtvann



Kaldtvann



Ikke bruk silikon som inneholder eddiksyre!



I dette området skal veggen forsterkes.



Innfelt ventil



Quattro fire-veis omstilling

Quattro



Trio universal stenge- og omstillingsventil



Utgangen som ikke brukes kan tettes med en blindplugg.



Avløp ytelse skal være mer enn 50 l/min.



Avløp



Mål (se side 31)



Gjennomstrømningsdiagram
(se side 33)



Betjening (se side 38)



Rengjøring (se side 39) og vedlagt brossyre



Service deler (se side 40)







Prøvermerke (se side 44)



Montasje se side 31



Указания за безопасност

-  При монтажа трябва да се носят ръкавици, за да се избегнат наранявания поради притискане или порязване.
-  Позволено е използването на системата на душа само за къпане, хигиена и цели на почистване на тялото.
-  Не е позволено деца, както и възрастни с физически, умствени и / или сензорни ограничения да използват системата на душа без надзор. Не е позволено използването на системата на душа от лица, употребили алкохол или дрога.
-  Трябва да се избягва контакта на струите на разпръсквателя с чувствителни части на тялото (напр. очите). Между разпръсквателя и тялото трябва да се спазва достатъчно разстояние.
-  Рамото на разпръсквателя за главата е разработена само, за да държи разпръсквателя за главата, то не бива да се натоварва с други предмети!

Указания за монтаж

- Преди монтажа продуктът трябва да се провери за транспортни щети.
- Арматурата трябва да се монтира, промие и провери в съответствие с валидните норми!

















Технически данни

Работно налягане: макс. 0,6 МПа
 Препоръчително работно налягане: 0,15 – 0,4 МПа
 (1 МПа = 10 bar = 147 PSI)
 Температура на горещата вода: макс. 60°C
 Термична дезинфекция: макс. 70°C / 4 мин

Този продукт не може да се използва във връзка с хидравлично и термично управляеми проточни нагреватели.

Продуктът е разработен само за питейна вода!

Описание на символите





-  Среда на коритото на душ-кабината
-  Топла вода
-  Студена вода
-  Не използвайте силикон, съдържащ оцетна киселина!
-  В тази област е необходимо подсилване на стената.
-  Клапан за мазилка
-  Четирипътно превключване Quattro
- Quattro**
 Спирателен и превключващ клапан Trio Universal
- Trio**
 Излишният извод може да се уплътни с глуха пробка.
-  Мощността на изтичане трябва да бъде повече от 50 л/мин.
- >50l/min**
 Отвеждане
- Raindrain**
 **Размери** (вижте стр. 31)
-  **Диаграма на потока** (вижте стр. 33)
-  **Обслужване** (вижте стр. 38)
-  **Почистване** (вижте стр. 39) и приложена брошура
-  **Сервизни части** (вижте стр. 40)
-  **Контролен знак** (вижте стр. 44)



Монтаж вижте стр. 31



Udhëzime sigurie

-  Për të evituar lëndimet e pickimeve ose të prerjeve gjatë procesit të montimit duhet që të vishni doreza.
-  Sistemi i dushit duhet të përdoret vetëm qëllimet e banjave, të higjienës dhe të larjes së trupit.
-  Fëmijët dhe të rriturit me aftësi të kufizuara fizike, mendore dhe/ose ndijuese nuk duhet ta përdorin sistemin e dushit pa qenë nën mbikëqyrje. Personat që janë nën ndikimin e drogave ose të alkoolit nuk duhet ta përdorin sistemin e dushit.
-  Kontakti i valëve të dushit me pjesët e ndjeshme të trupit (p.sh. me sytë) duhet që të shmanget. Midis dushit dhe trupit duhet që të mbahet një distancë e mjaftueshme.
-  Mbatësja e kokës së dushit është projektuar vetëm për mbajtjen e kokës së dushit dhe nuk duhet që të rëndohet me objekte të tjera!

(shih faqen _1w)

- Përpara montimit duhet që produkti të kontrollohet për dëmtime nga transporti.
- Armatura duhet montuar, shpërlarë dhe kontrolluar në bazë të normave të vlefshme!

Të dhëna teknike

Presioni gjatë punës	maks. 0,6 MPa
Presioni i rekomanduar: (1 MPa = 10 bar = 147 PSI)	0,15 – 0,4 MPa
Temperatura e ujit të ngrohtë	maks. 60°C
Dezinfektim Termik:	maks. 70°C / 4 min

Ky produkt nuk mund të përdoren me ngrohës elektrikë të ujit të drejtuar në mënyrë hidraulike ose termike.

Produkti është projektuar ekskluzivisht për ujë të pijshëm!

Përshkrimi i simbolit



Mesi i vaskës së dushit



Uji i ngrohtë



Uji i ftohtë



Mos përdorni silikon që në përbërje ka acid acetik.



Në këtë zonë është i nevojshëm një përforsim i murit.



Ventili i suvajës



Valvul devijuese Quattro me katër drejtime

Quattro



Valvul universale Trio për bllokim dhe devijim

Trio



Dalja që nuk nevojitet duhet izoluar me tapë qorre.



Kapaciteti i shkarkimit duhet të jetë më shumë se 50 l/minutë.



Shkarkimi



Përmasat (shih faqen 31)



Diagrami i qarkullimit
(shih faqen 33)



Përdorimi (shih faqen 38)



Pastrimi (shih faqen 39) dhe broshura bashkëngjitur



Pjesë ndërrimi (shih faqen 40)



Shenja e kontrollit
(shih faqen 44)



Montimi shih faqen 31



وصف الرمز

تنبيهات الأمان



يجب ارتداء قفازات لليد أثناء التركيب لتجنب حدوث أخطار الإنحشار أو الجروح.

يجب استخدام نظام الدش فقط لأغراض الإستحمام والأغراض الصحية وأغراض تنظيف الجسم.

ممنوع استخدام نظام الدش بدون ملاحظة من البالغين سواء في حالة استخدامه من طرف أطفال أو البالغين يعانون من قصور جسدي أو عقلي أو عصبي يمنعهم من الإحساس بدرجات حرارة المياه. لا يسمح لأي شخص تحت تأثير تناول الكحول أو المخدرات من استخدام نظام الدش.

يجب تجنب حدوث اتصال مباشر بين الماء الخارج من رأس الدش وبين أجزاء الجسم الحساسة (مثل العينين). يجب وجود مسافة كافية بين رأس الدش والجسم.

وظيفة ذراع دس الرأس هي فقط الإمساك بدش الرأس، ولذلك يجب عدم التحميل عليه بأشياء أخرى.

بانيو مزود بدش في المنتصف



ماء دافئ



ماء بارد



هام! لا تستخدم السليكون الذي يحتوي على أحماض!



يلزم هذا في النطاق وجود تقوية للحناط.



صمام التدفق



تغيير مسار رباعي كواترو



Quattro

صمام حجز وتغيير تريبو يونيفرسال



Trio

قم بسد المنفذ غير المستخدم.



يجب أن تكون قدرة الصرف أكبر من 50 لتر/دقيقة



تصريف



Raindrain

أبعاد (راجع صفحة 31)



رسم للصرف

(راجع صفحة 33)



التشغيل (راجع صفحة 38)



التنظيف (راجع صفحة 39) والكتيب المرفق



قطع الغيار (راجع صفحة 40)



شهادة اختبار (راجع صفحة 44)



تعليمات التركيب

- قبل القيام بعملية التركيب، يجب فحص المنتج للتأكد من خلوه من أية تلفيات ناتجة عن النقل.
- يجب تركيب الوصلة، وغمرها بالماء واختبارها وفقاً للمعايير السارية!

المواصفات الفنية

ضغط التشغيل: الحد الأقصى 0,6 ميجاباسكال
 ضغط التشغيل الموصى به: 0,4 – 0,15 ميجاباسكال
 (1 ميجاباسكال = 10 بار = 147 PSI)
 درجة حرارة الماء الساخن: الحد الأقصى 60°C
 تعقيم حراري: الحد الأقصى 70°C / 4 الدقيقة

لا يمكن استعمال هذا المنتج مع سخانات الماء الفورية الهيدروليكية أو الحرارية.

المنتج مخصص فقط لماء الشرب!



التركيب راجع صفحة 31

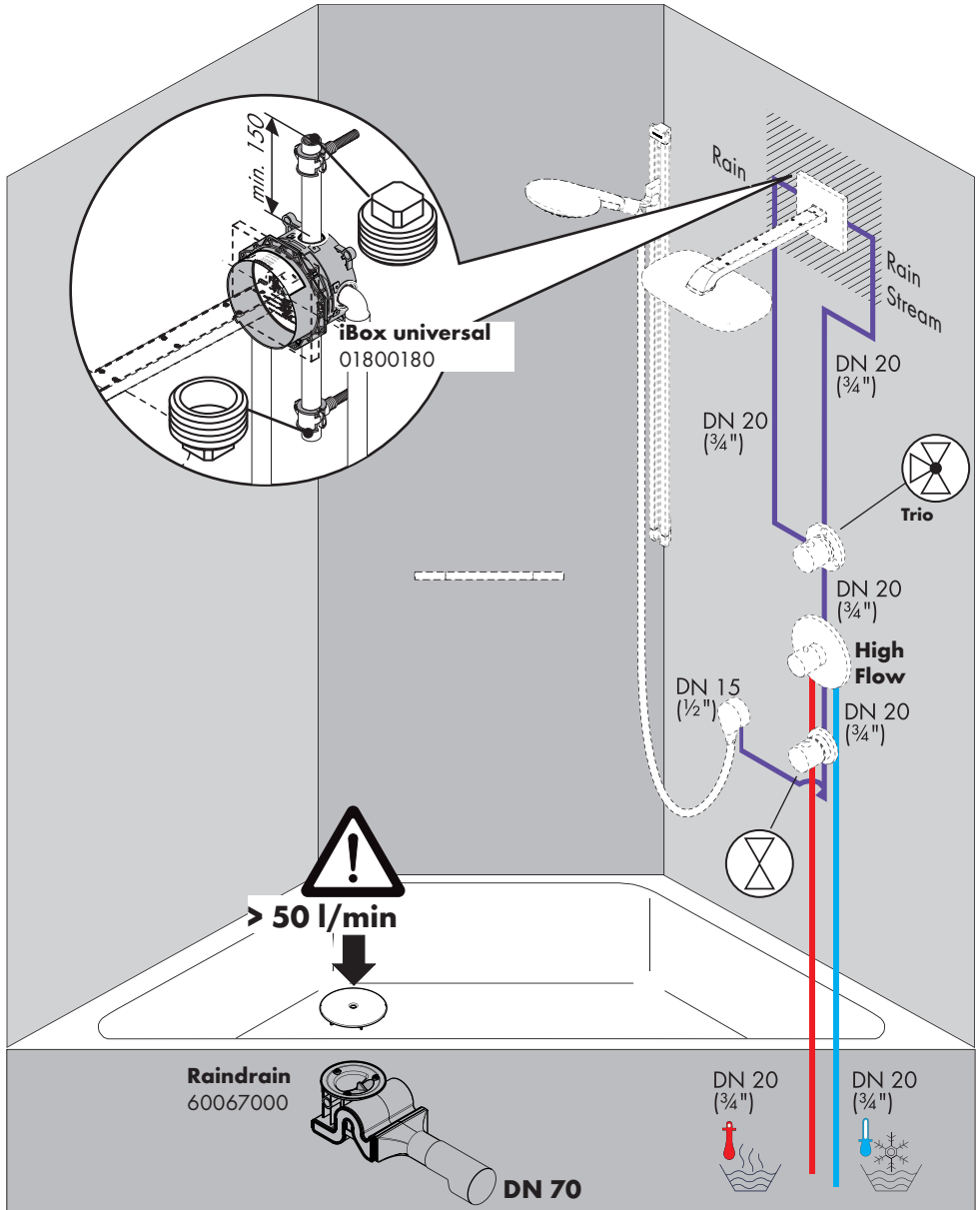

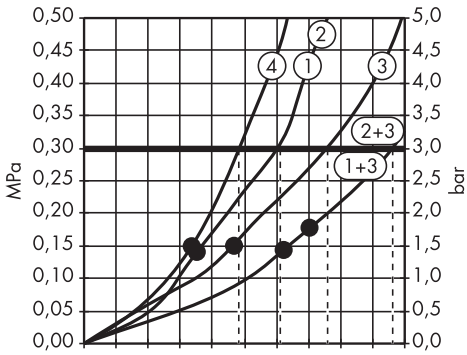

Q = l/min 0 3 6 9 12 15 18 21 24 27 30
Q = l/sec 0 0,1 0,2 0,3 0,4 0,5

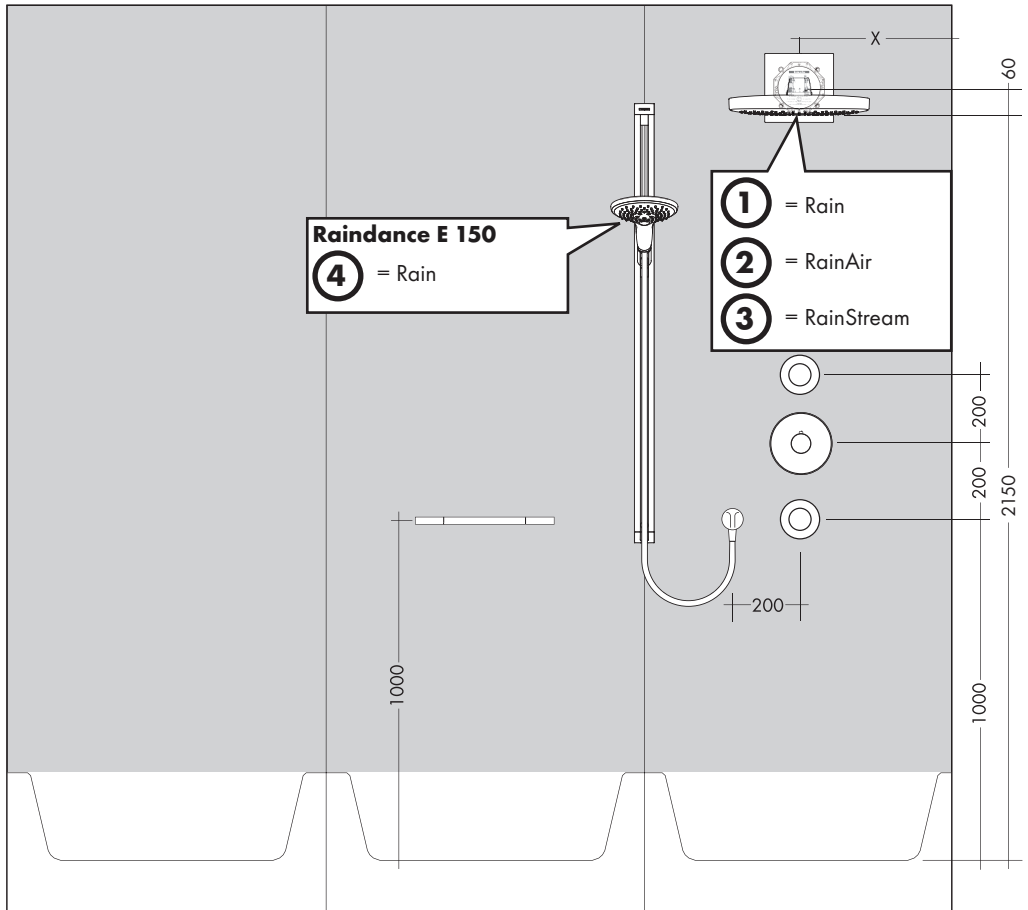

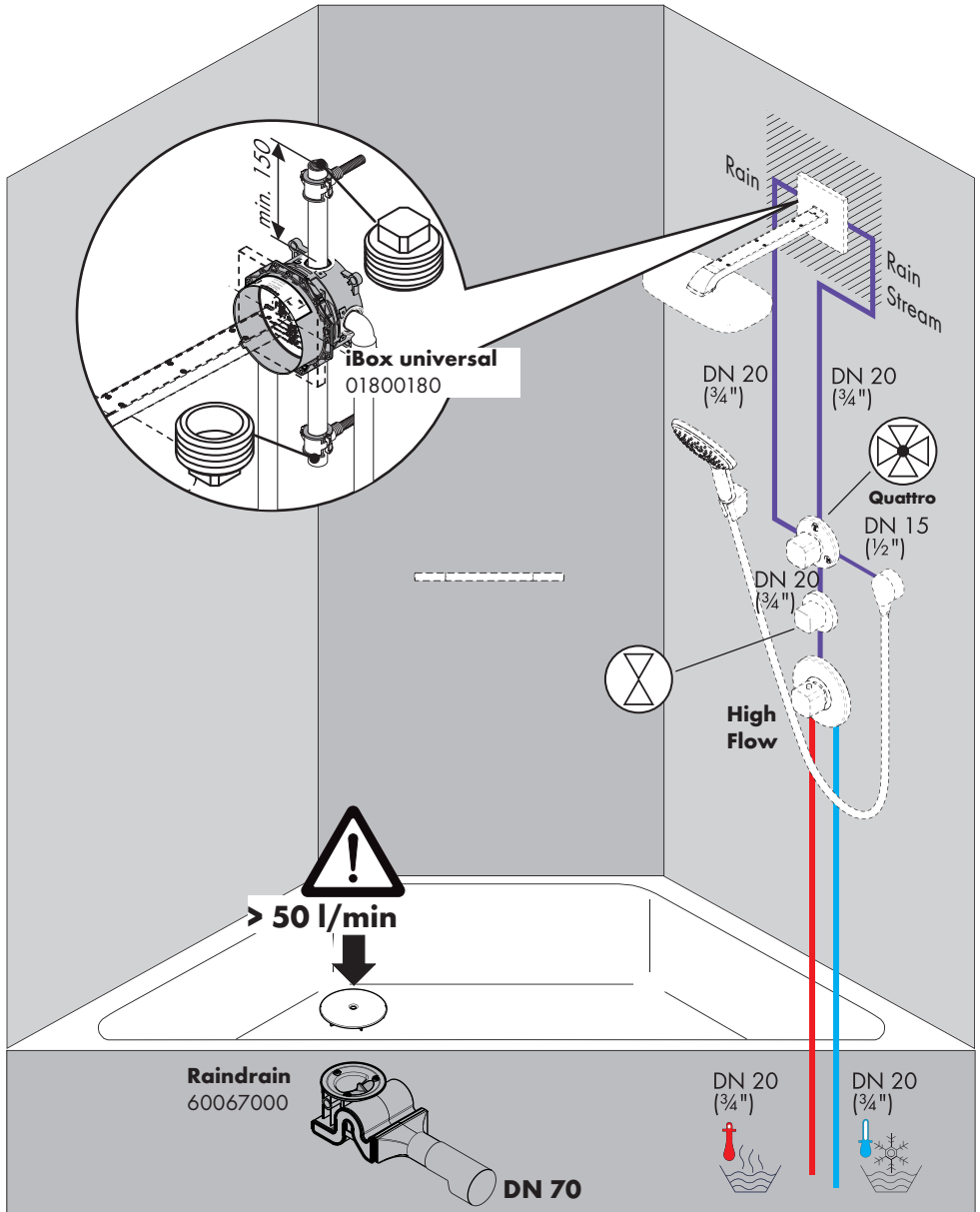

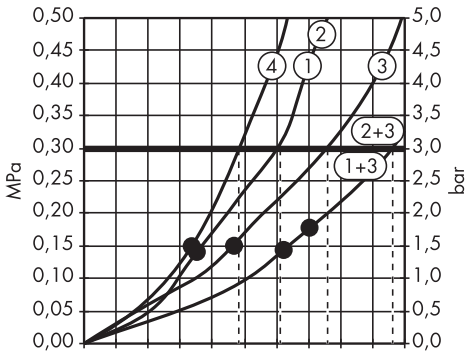

Q = l/min 0 3 6 9 12 15 18 21 24 27 30
 Q = l/sec 0 0,1 0,2 0,3 0,4 0,5

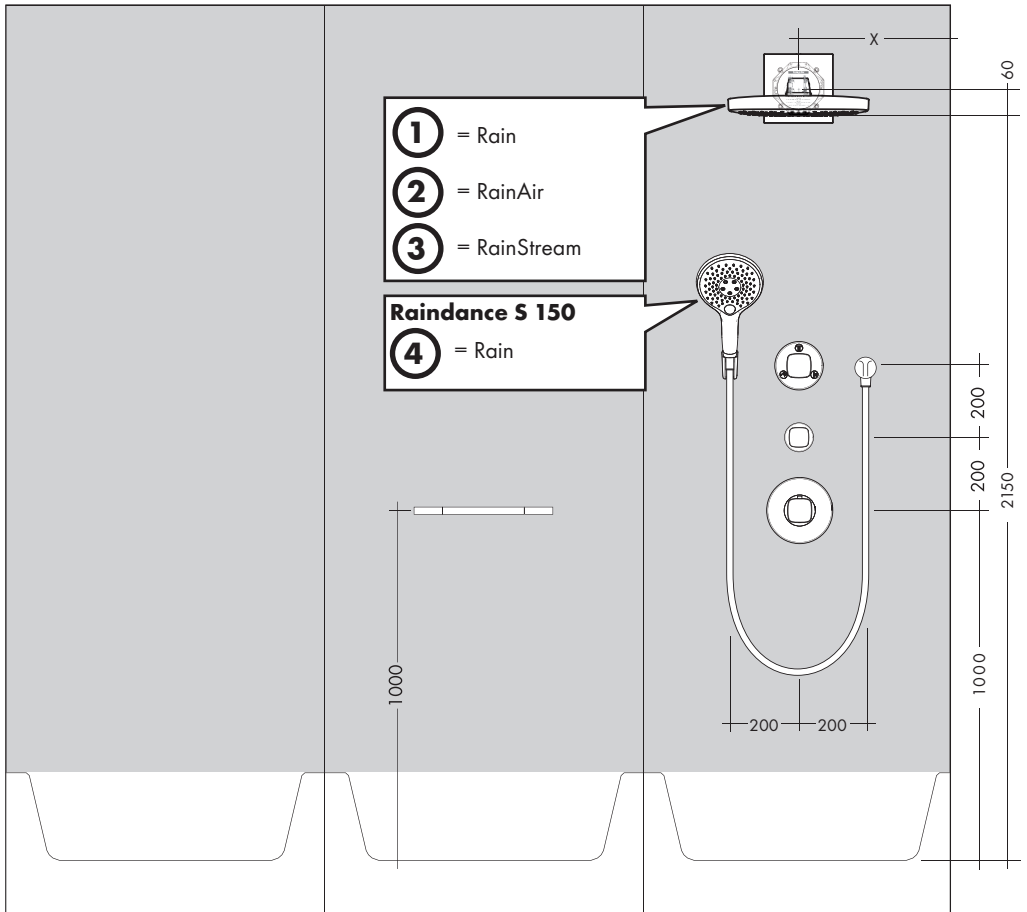

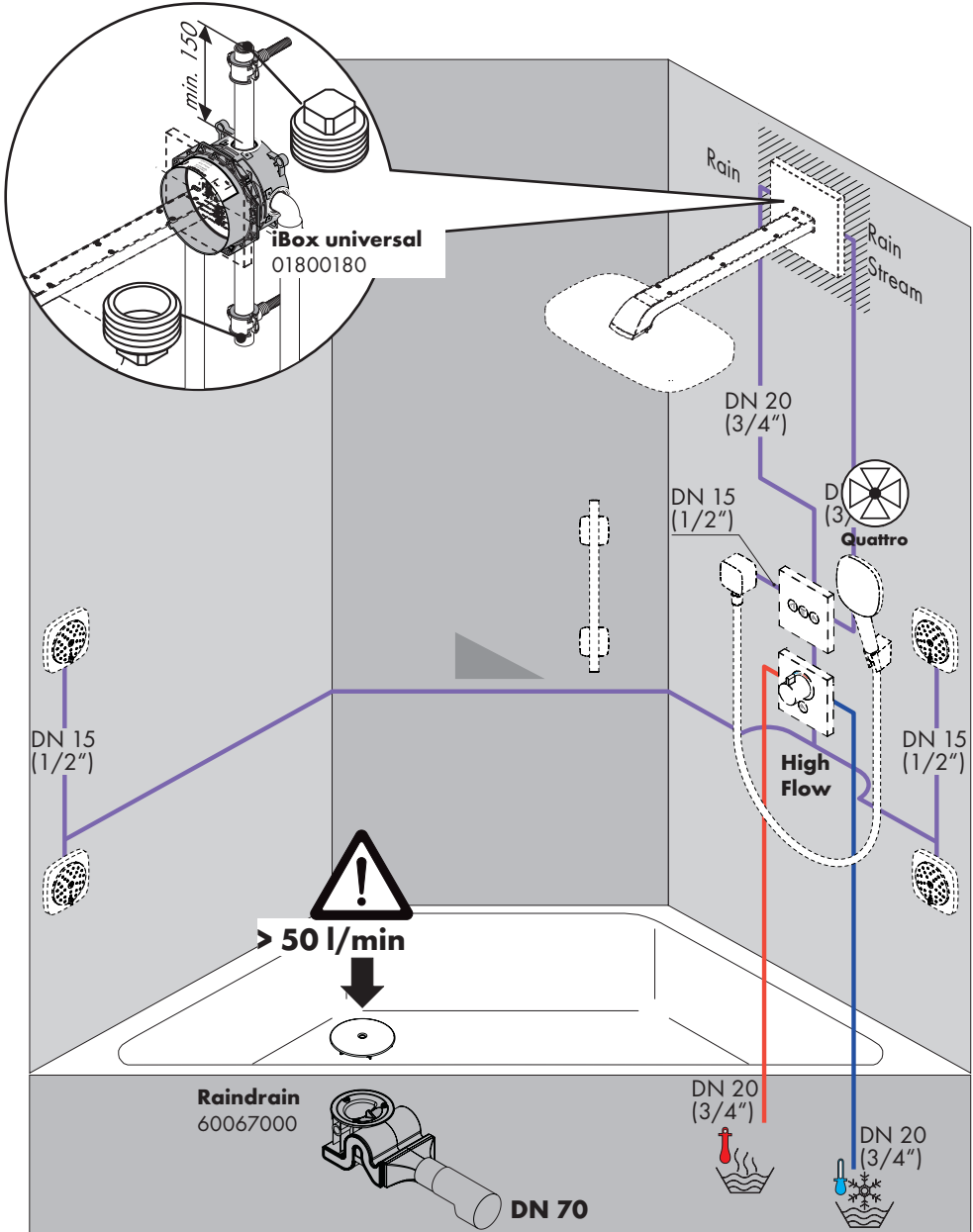

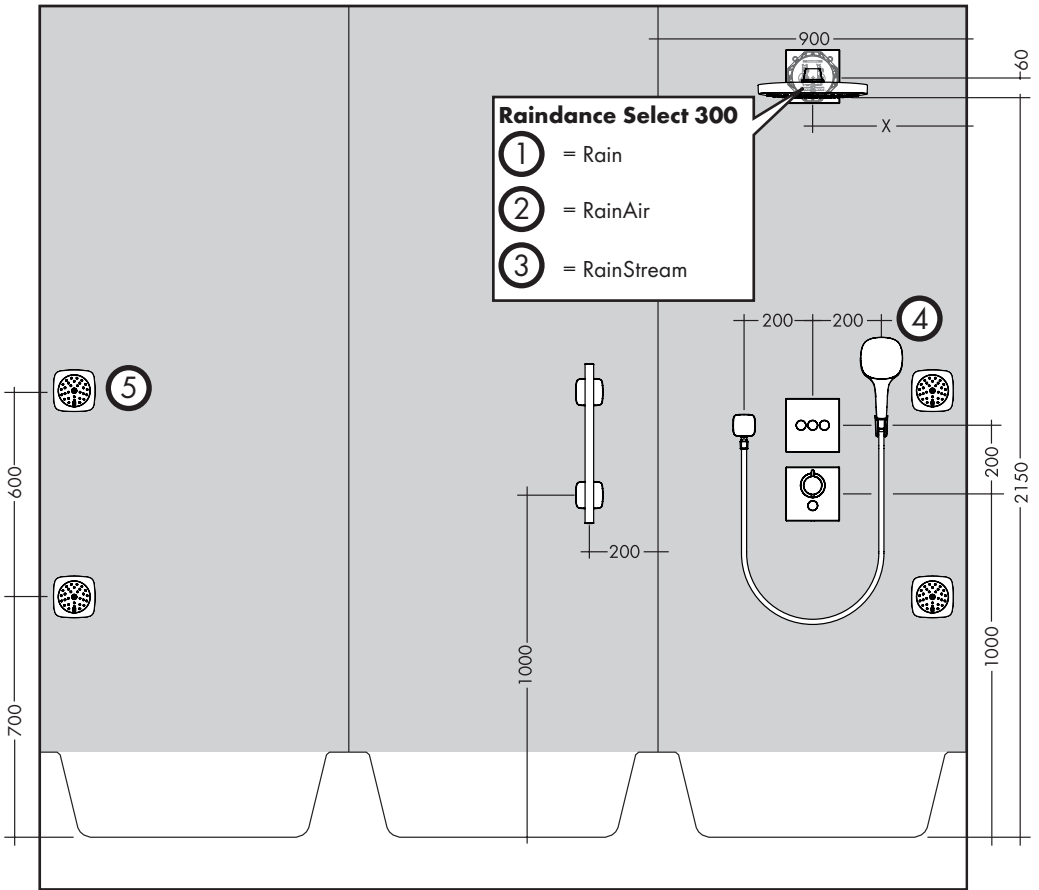
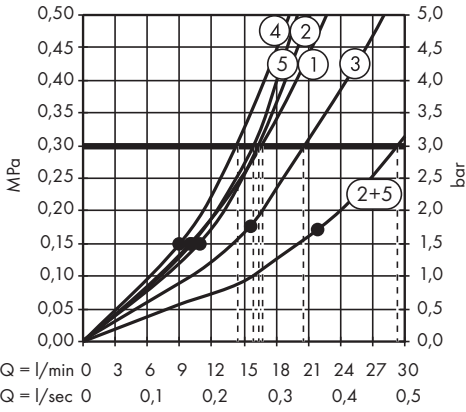

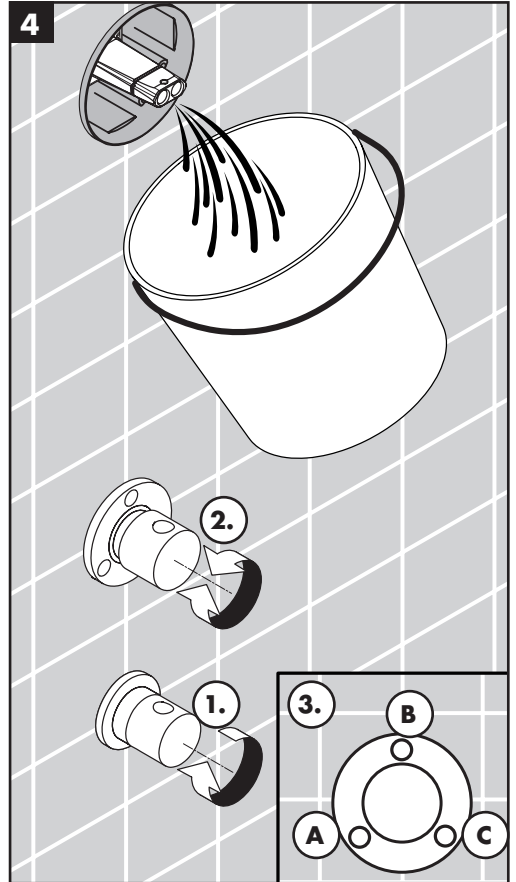
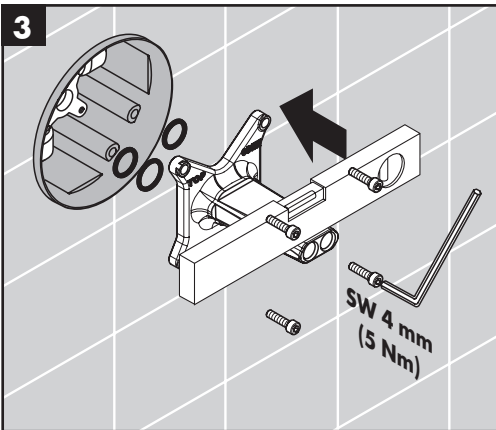
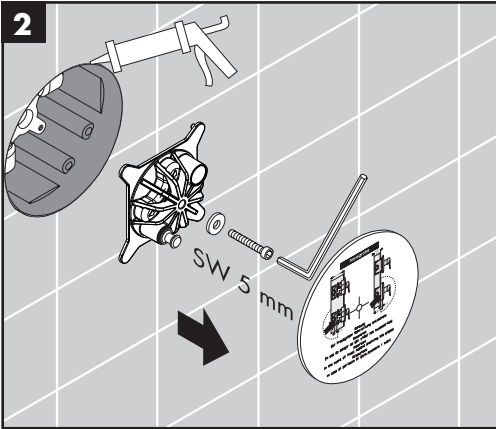
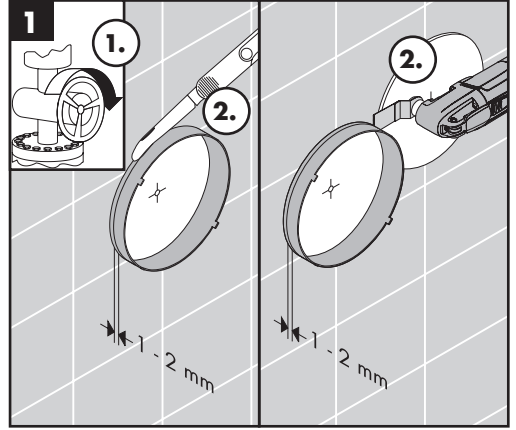
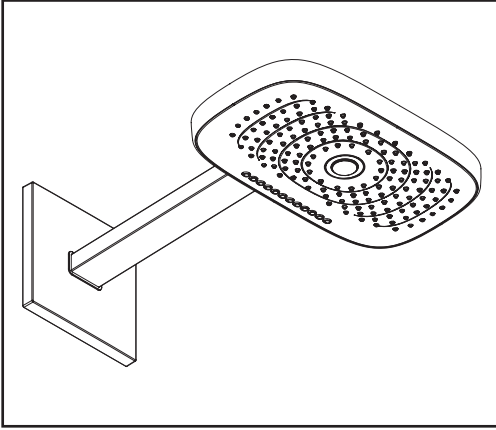

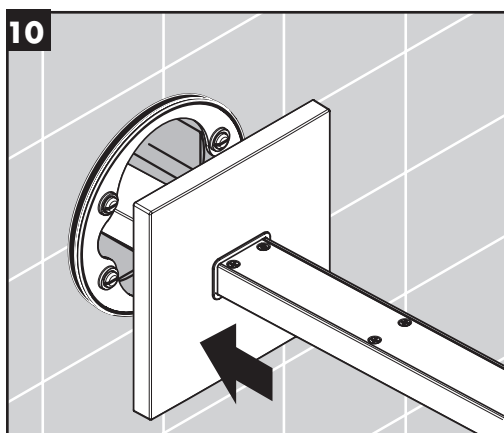
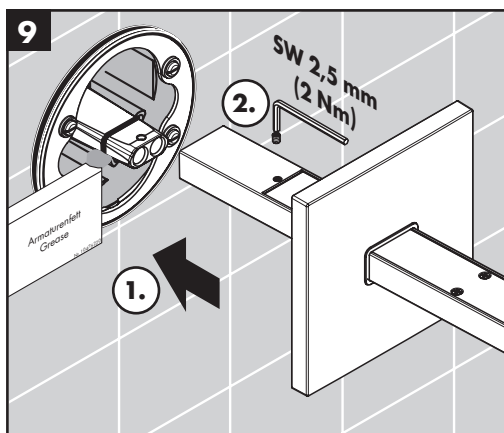
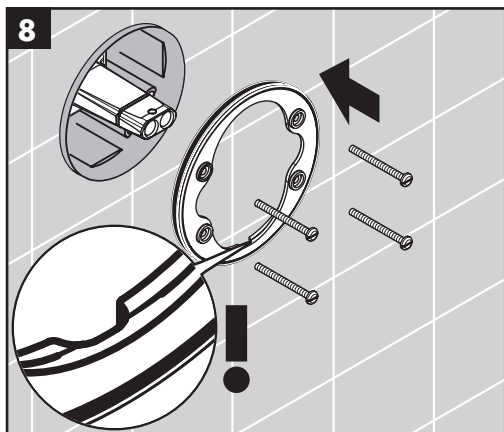
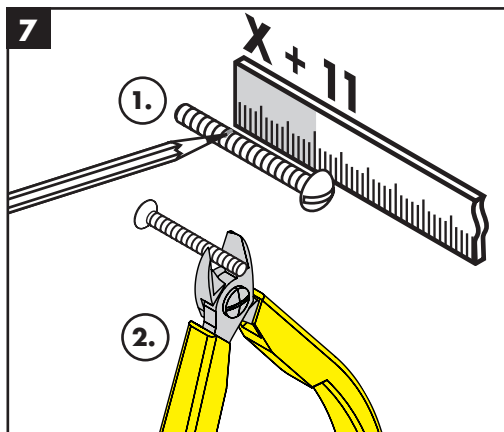
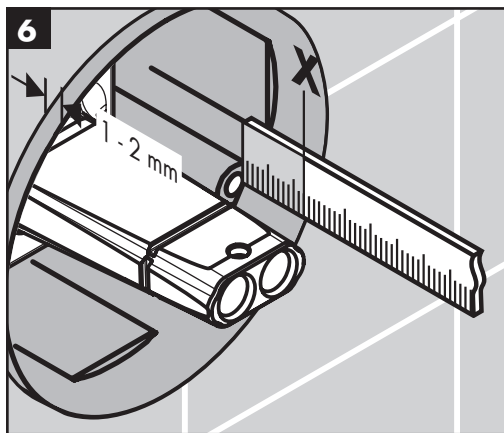
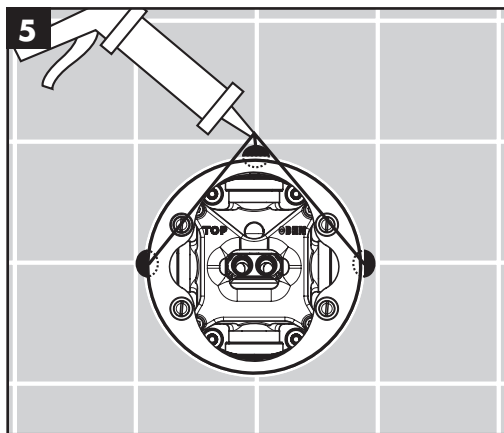

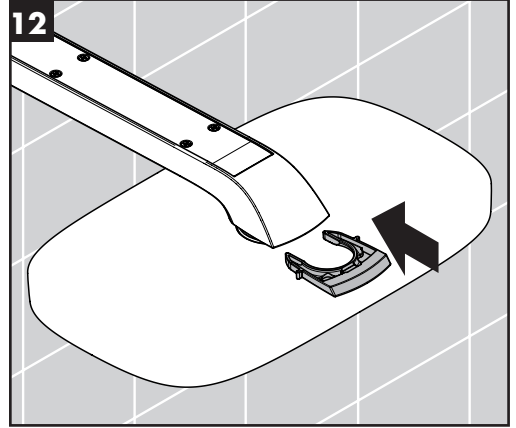
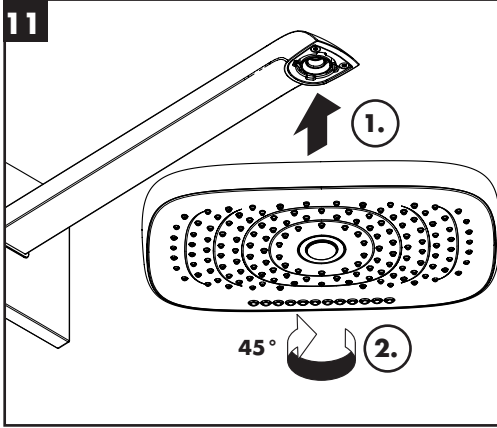

Rain

RainAir

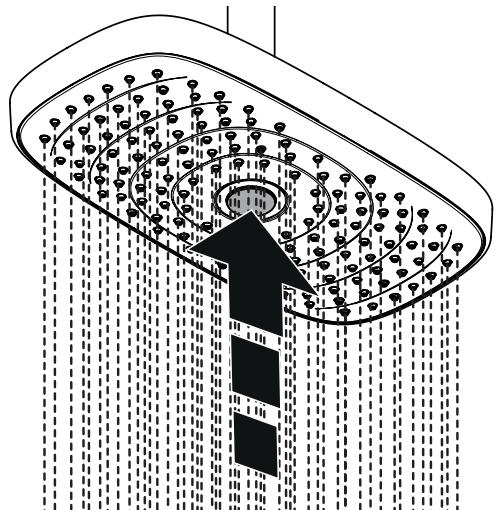
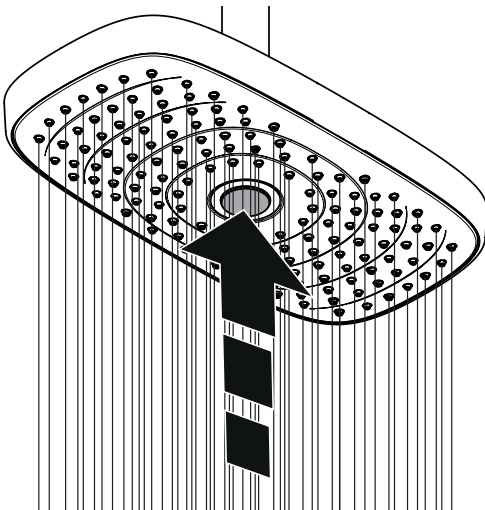

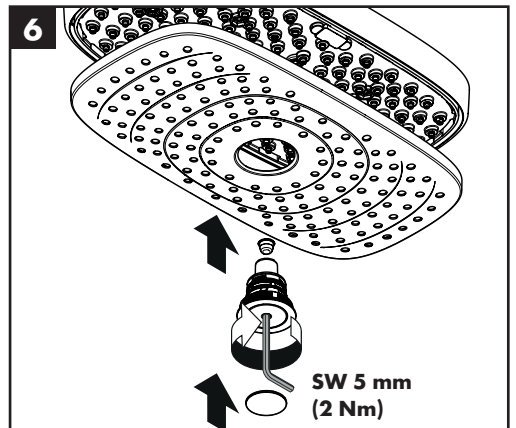
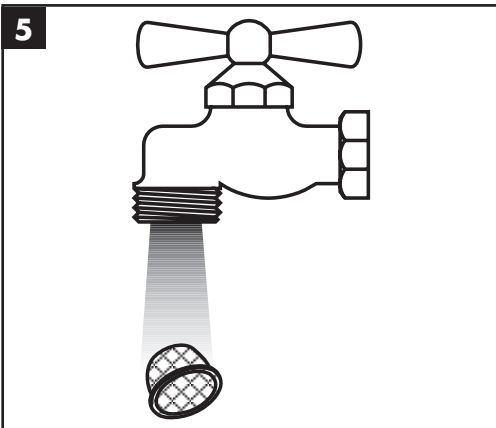
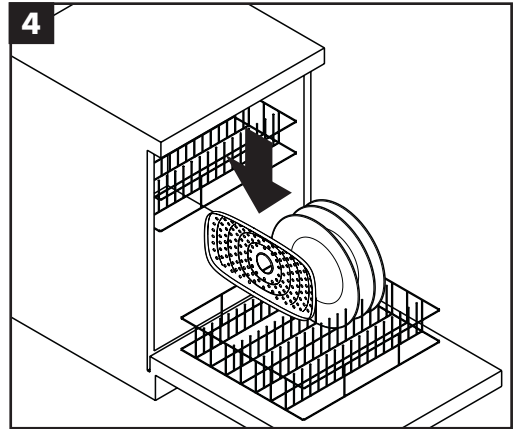
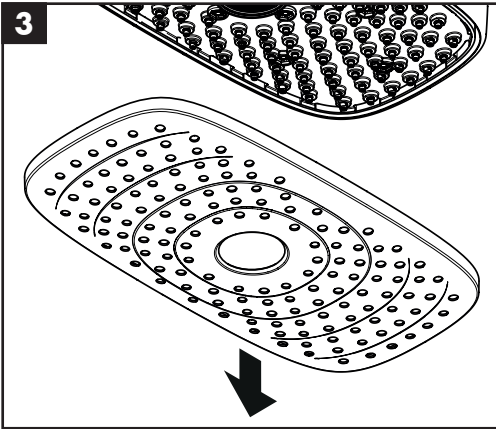
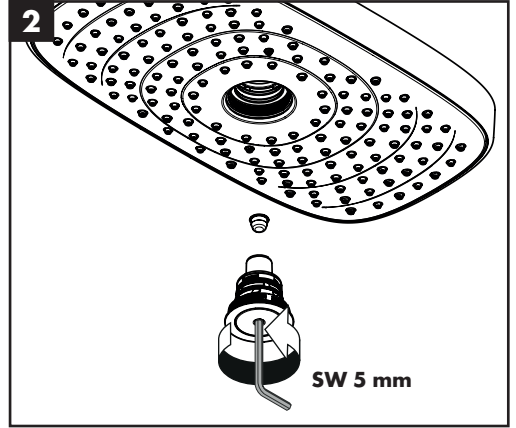
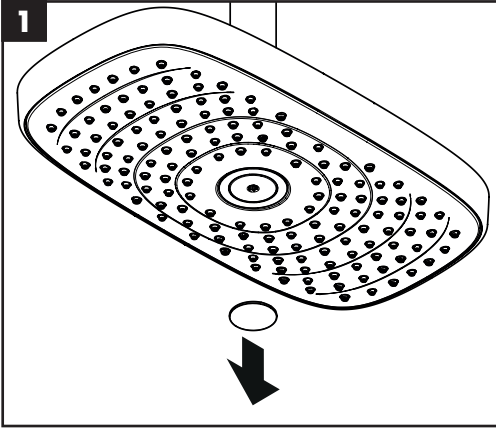



Raindance Select

26468000 / 26468400

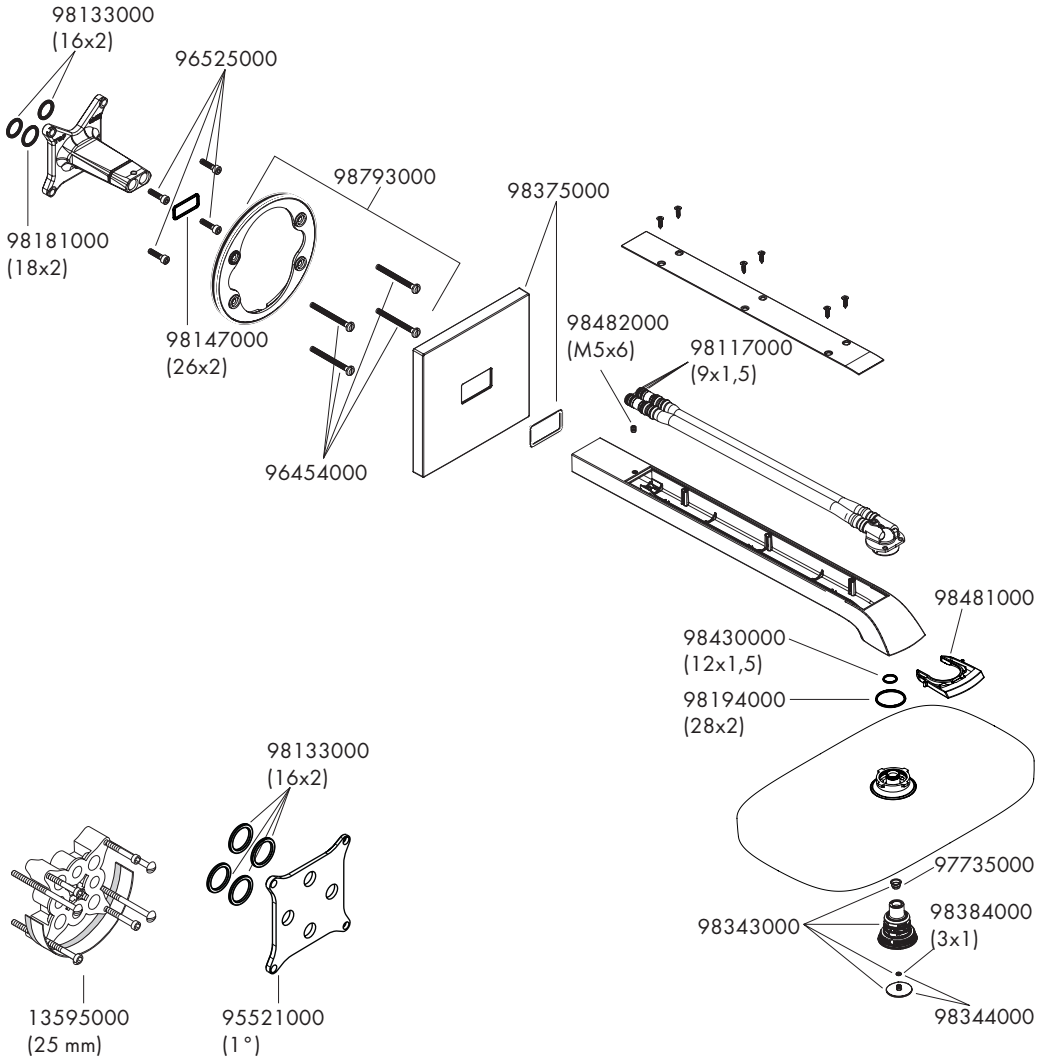



P-IX

DVGW

SVGW

WRAS

KIWA

NF

ACS

ETA

26468XXX

X

hansgrohe

Hansgrohe · Auestraße 5 · 9 · D-77761 Schiltach · Telefon +49 (0) 78 36/51-1282 · Telefax +49 (0) 7836/51 1440
E-Mail: info@hansgrohe.com · Internet: www.hansgrohe.com

01/2015
9.02181.01