

Utåtgående sidhängd
Trä Fönster 3-glas
Skala 1:2

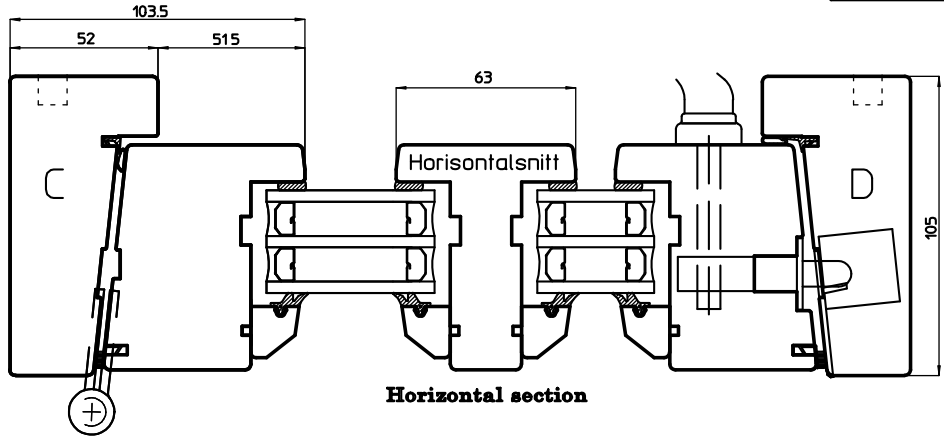

Horizontal section

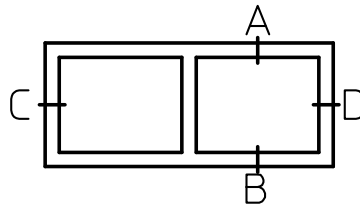
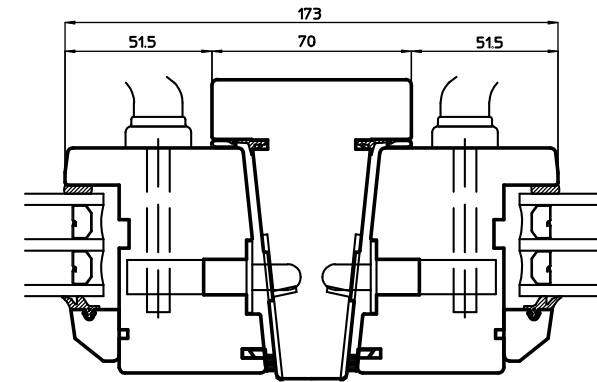

Horizontalsnitt 2-luft
Horizontal section 2 lights

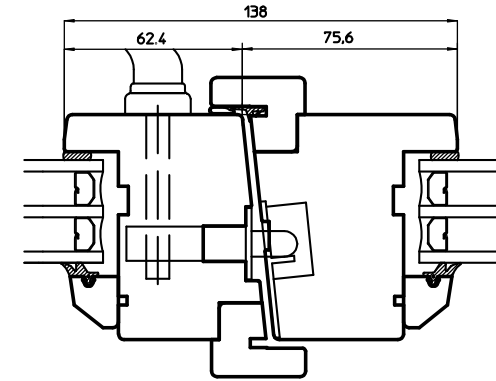

Horizontalsnitt mötesbåge
Horizontal section abutting casements

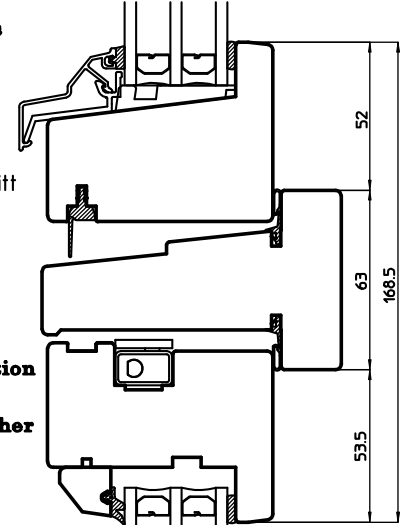

Vertikalsnitt
2-luft
på höjden

Vertical section
2 lights one
above the other

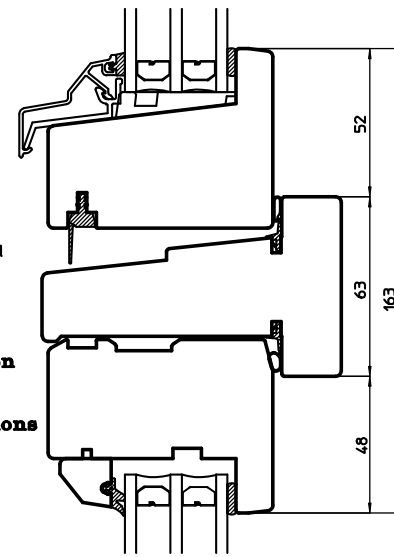

Kombination,
vertikalsnitt
sidhängt+
glidhängt på
höjden

Combination,
vertical section
casement and
slide suspensions
on vertical

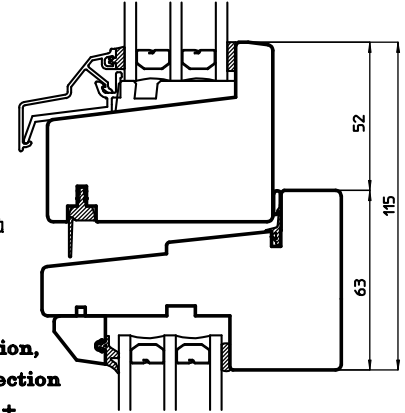

Kombination,
vertikalsnitt
sidhängt+
fast karm på
höjden

Combination,
vertical section
casement +
fixed frame on
vertical

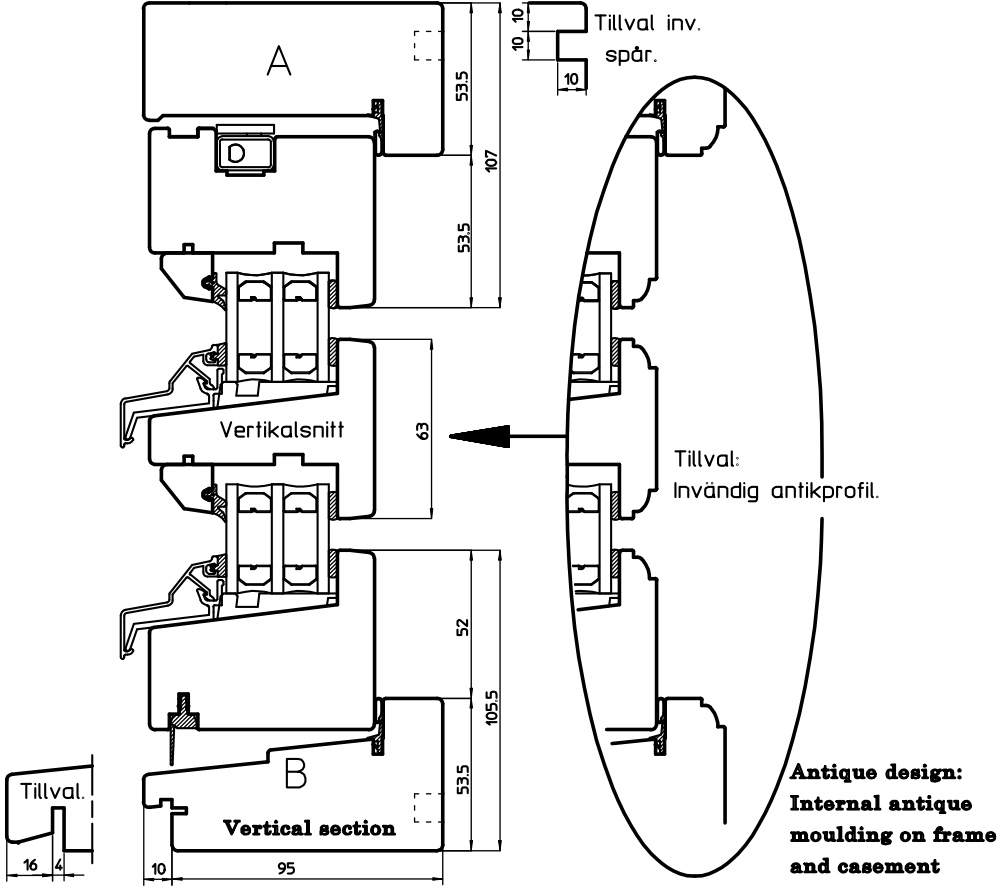

Antique design:
Internal antique
moulding on frame
and casement